



US00D680325S

(12) **United States Design Patent**
Froyd

(10) **Patent No.:** **US D680,325 S**

(45) **Date of Patent:** **** Apr. 23, 2013**

(54) **FIREARM ACCOMPANIMENT**

(76) Inventor: **George Froyd**, Houston, TX (US)

(**) Term: **14 Years**

(21) Appl. No.: **29/427,415**

(22) Filed: **Jul. 17, 2012**

(51) **LOC (9) Cl.** **03-01**

(52) **U.S. Cl.**
USPC **D3/222**

(58) **Field of Classification Search** D3/222-223,
D3/215, 221, 224, 226, 228, 230, 262; 224/236-237,
224/239, 240-242, 245, 672, 674, 911, 914,
224/931

See application file for complete search history.

(56) **References Cited**

U.S. PATENT DOCUMENTS

D410,331 S *	6/1999	Hamilton	D3/221
D440,041 S *	4/2001	Fermin	D3/226
D463,115 S *	9/2002	Snider et al.	D3/226
D463,117 S *	9/2002	Carter	D3/226
D556,449 S *	12/2007	Rogers	D3/262
D601,339 S *	10/2009	Zusman	D3/222

* cited by examiner

Primary Examiner — Catheri Oliver-Garcia

(74) *Attorney, Agent, or Firm* — John K. Buche; Scott Compton; Buche & Associates, P.C.

(57) **CLAIM**

The ornamental design for a firearm accompaniment, as shown and described.

DESCRIPTION

FIG. 1 is a front perspective view of a firearm accompaniment showing my new design;

FIG. 2 is a front view of the firearm accompaniment;

FIG. 3 is a rear view of the firearm accompaniment;

FIG. 4 is a right side view of the firearm accompaniment;

FIG. 5 is a left side view of the firearm accompaniment;

FIG. 6 is a top view of the firearm accompaniment;

FIG. 7 is a bottom view of the firearm accompaniment;

FIG. 8 is another front perspective view of the firearm accompaniment; and,

FIG. 9 is still another front perspective view of the firearm accompaniment.

The broken lines of the Figures, including the shotgun shells of FIGS. 8 and 9, illustrate environmental structure and portions of the firearm accompaniment that form no part of the claimed design.

1 Claim, 5 Drawing Sheets

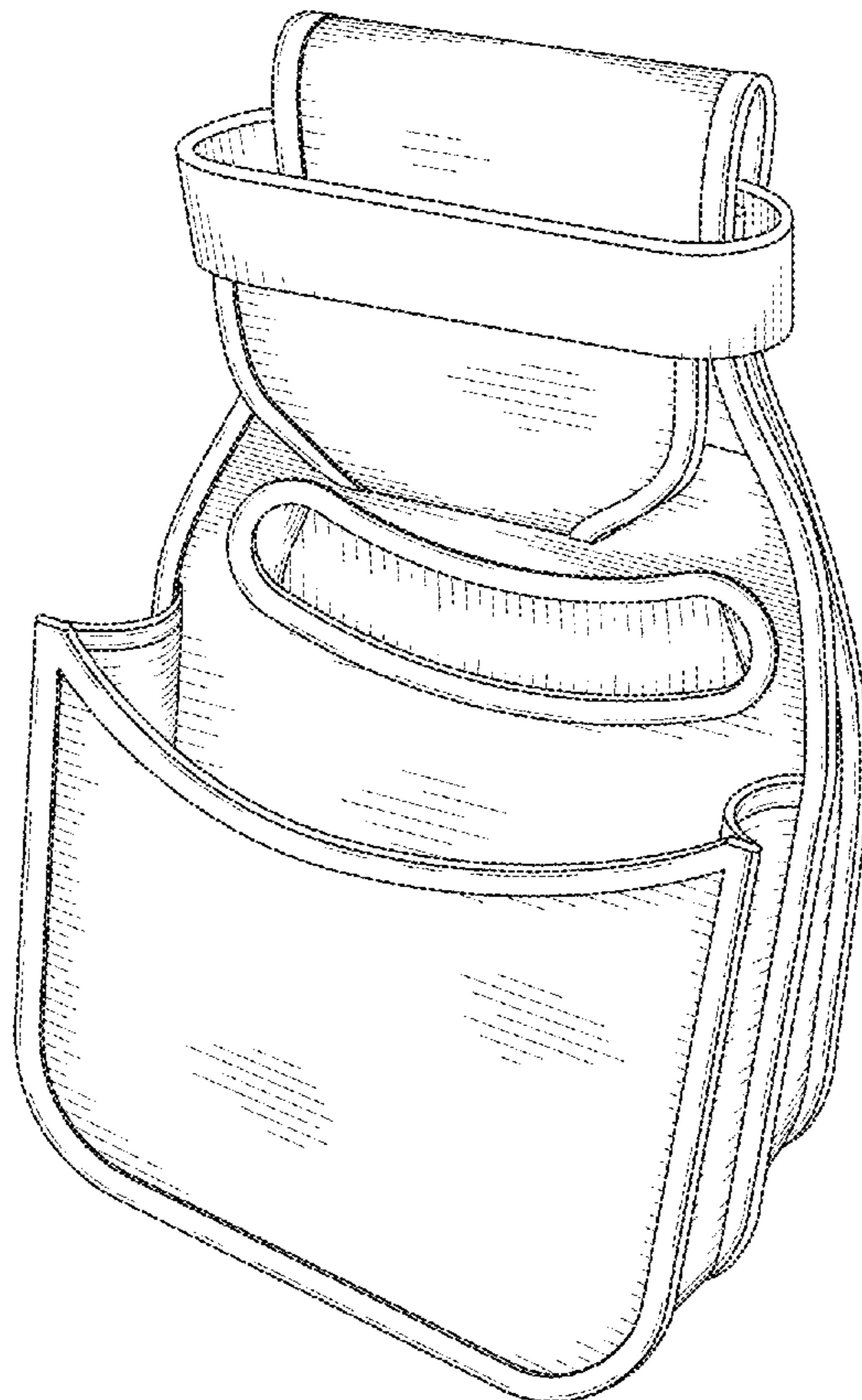

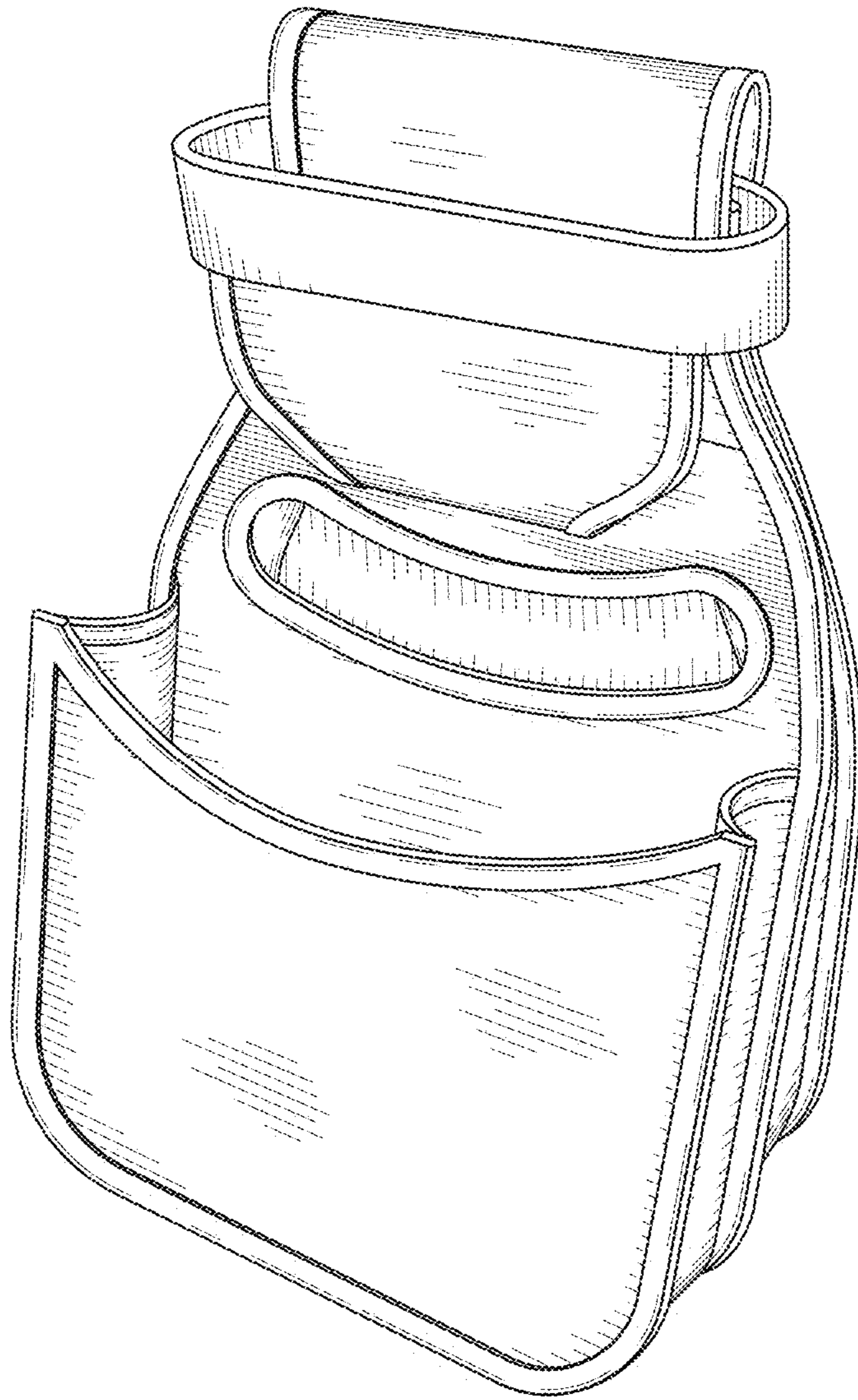

FIG. 1

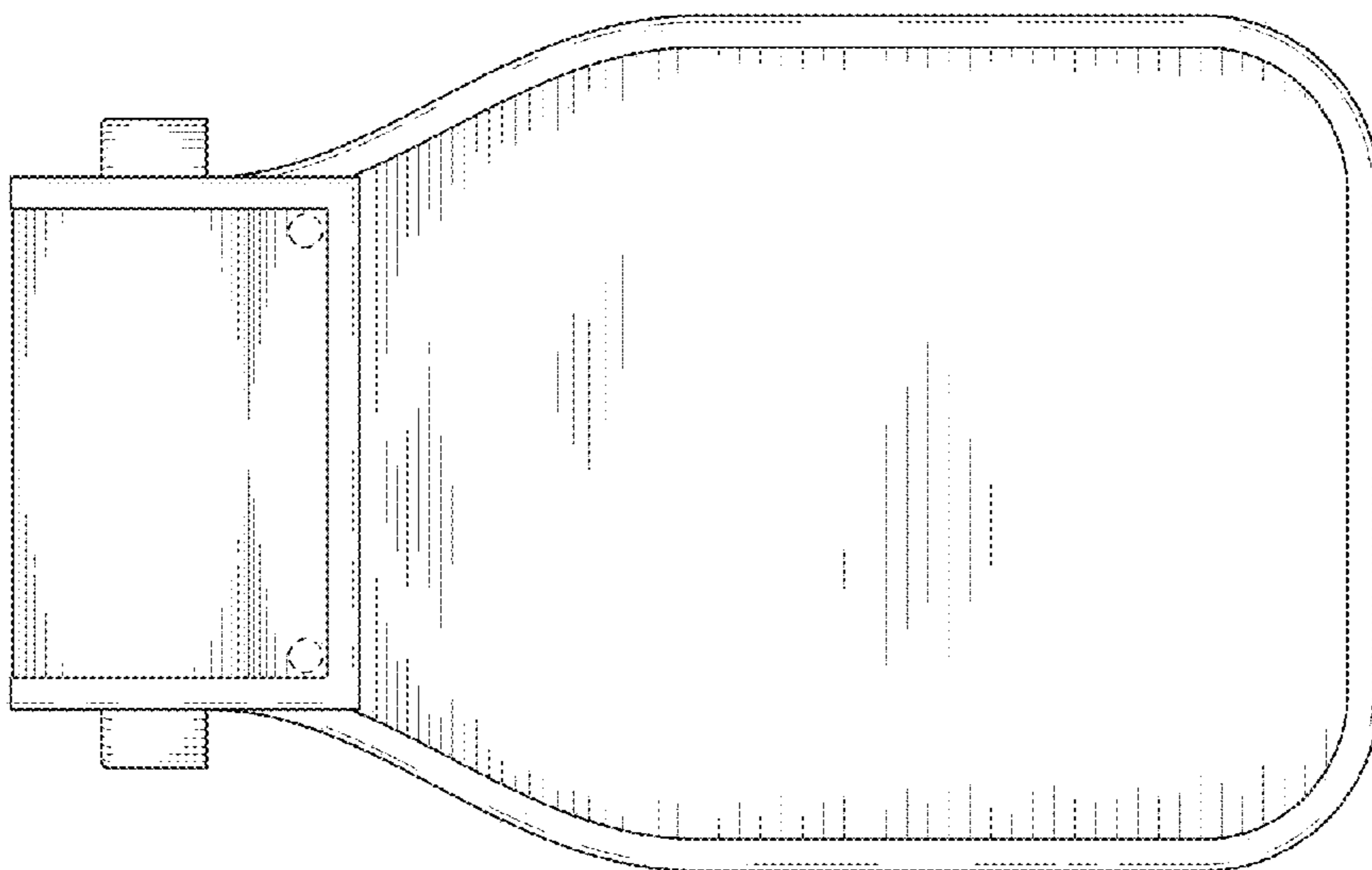

FIG. 3

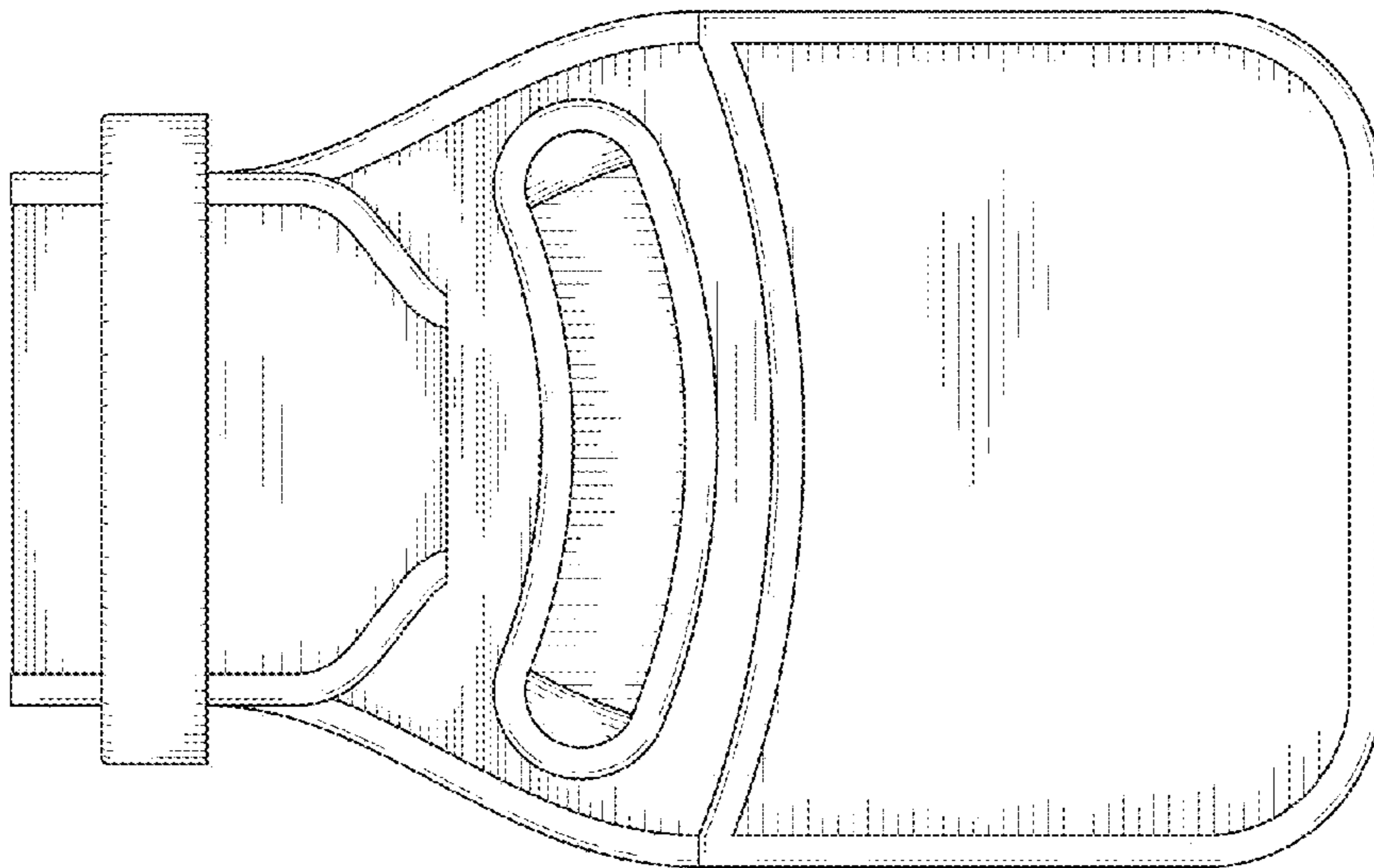

FIG. 2

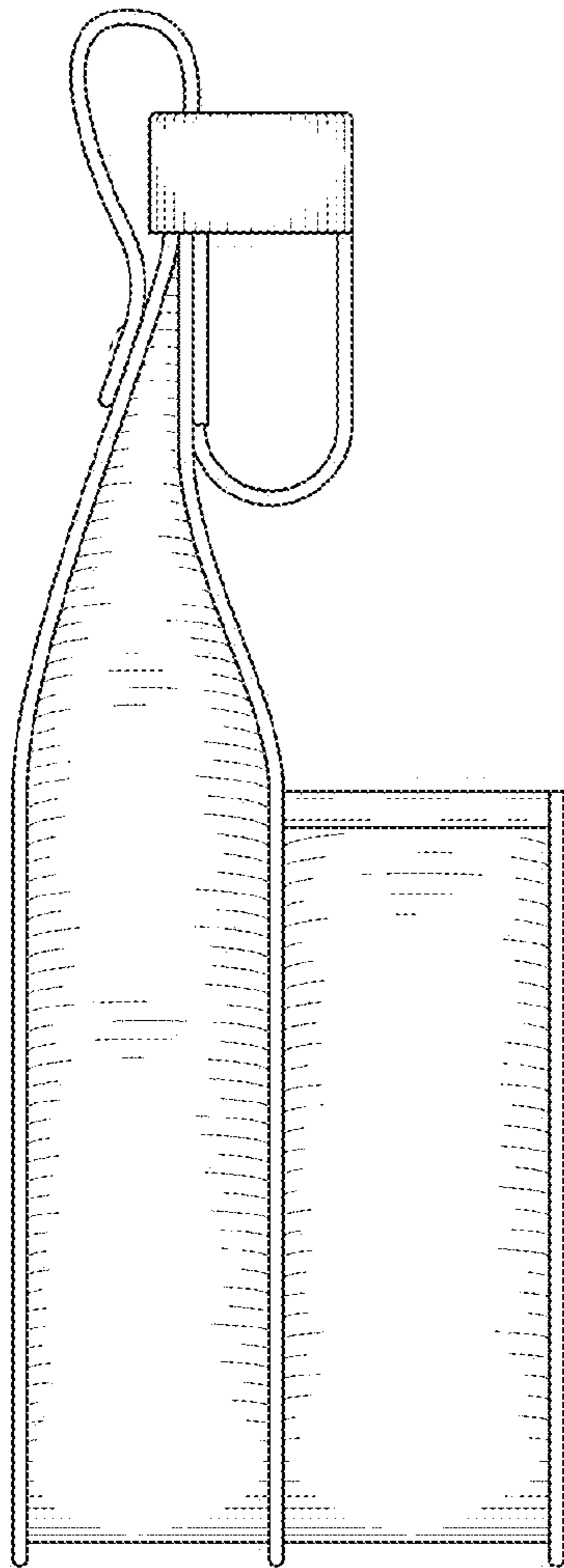

FIG. 4

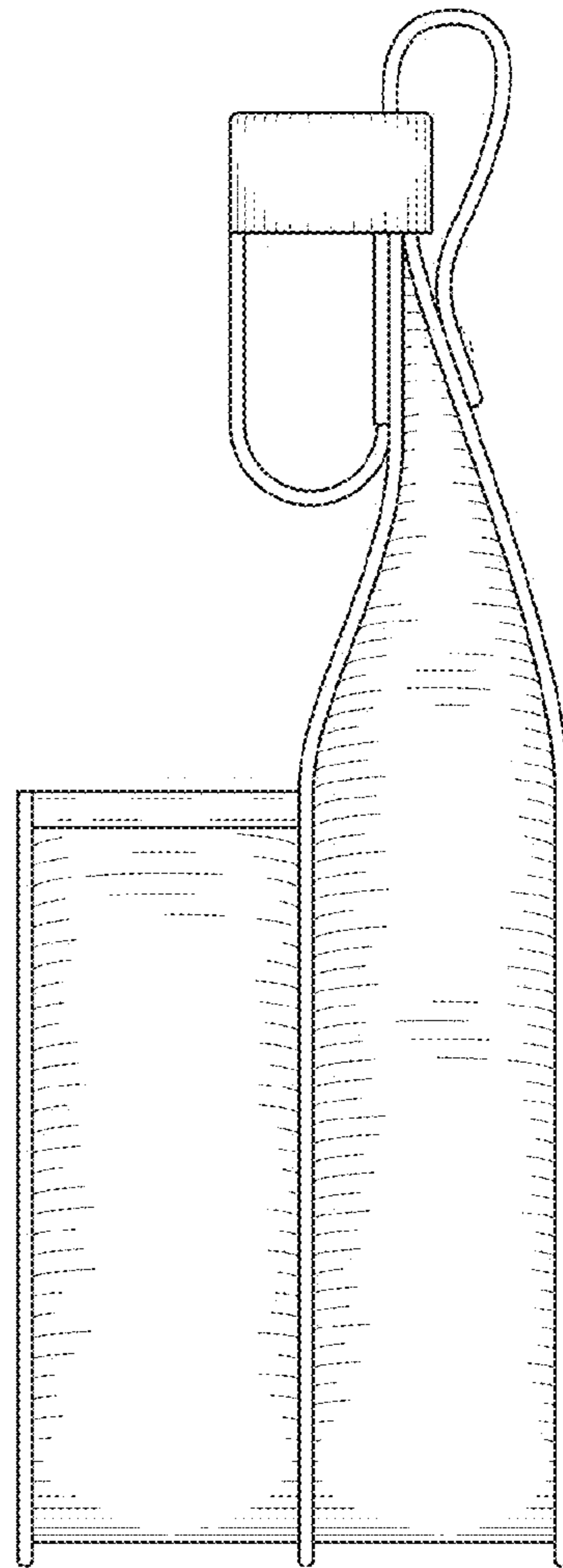

FIG. 5

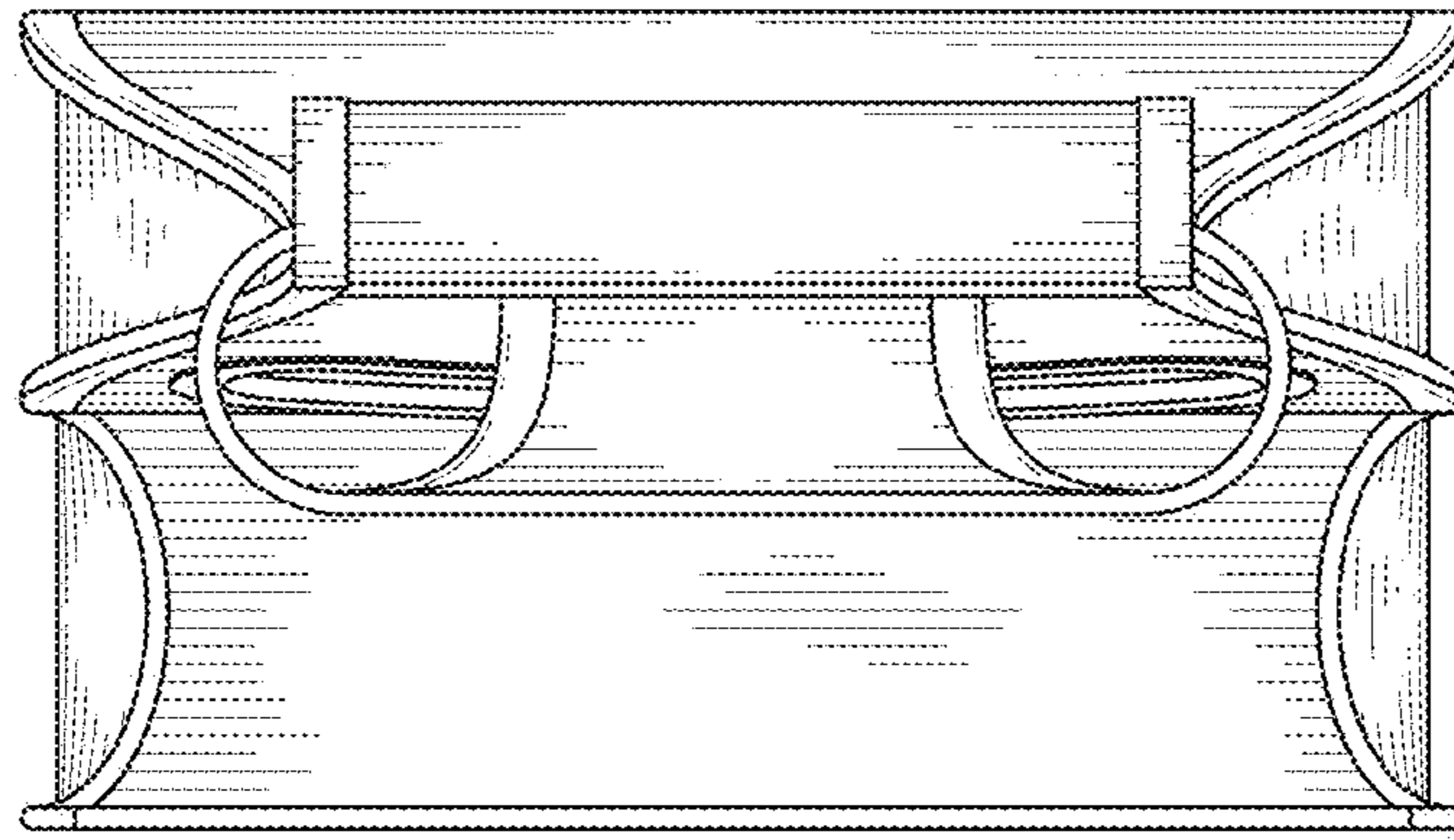

FIG. 6

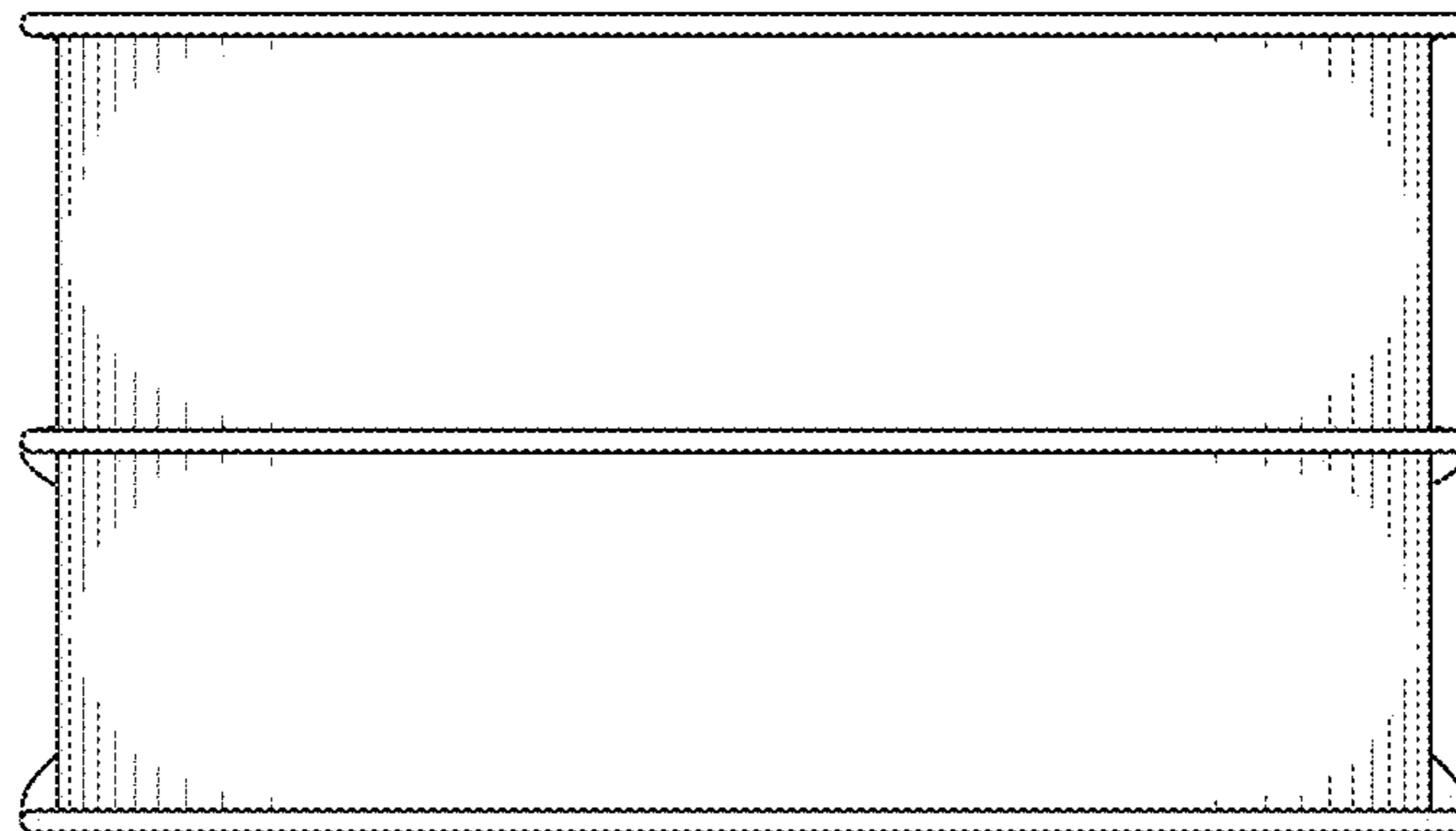

FIG. 7

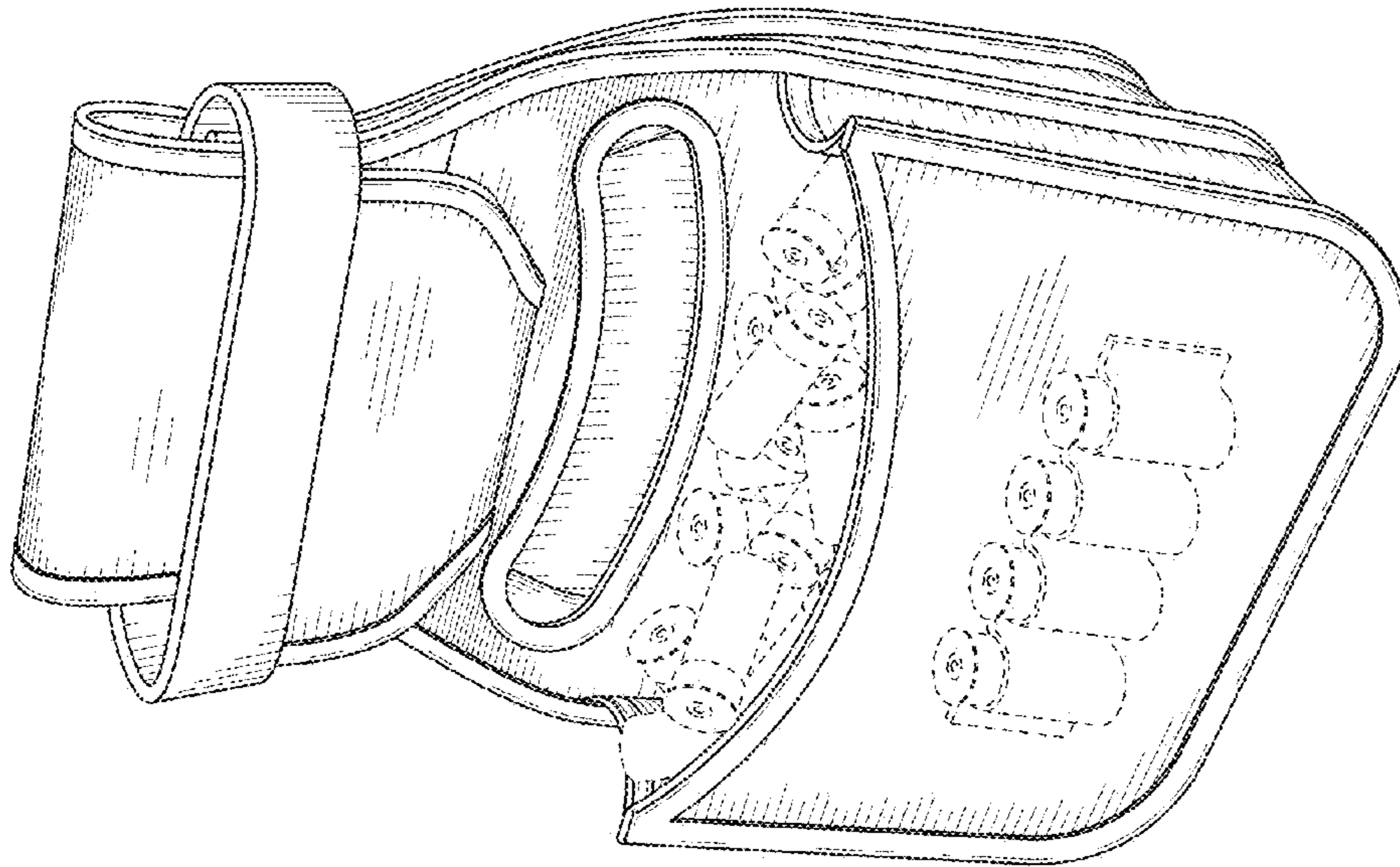

FIG. 9

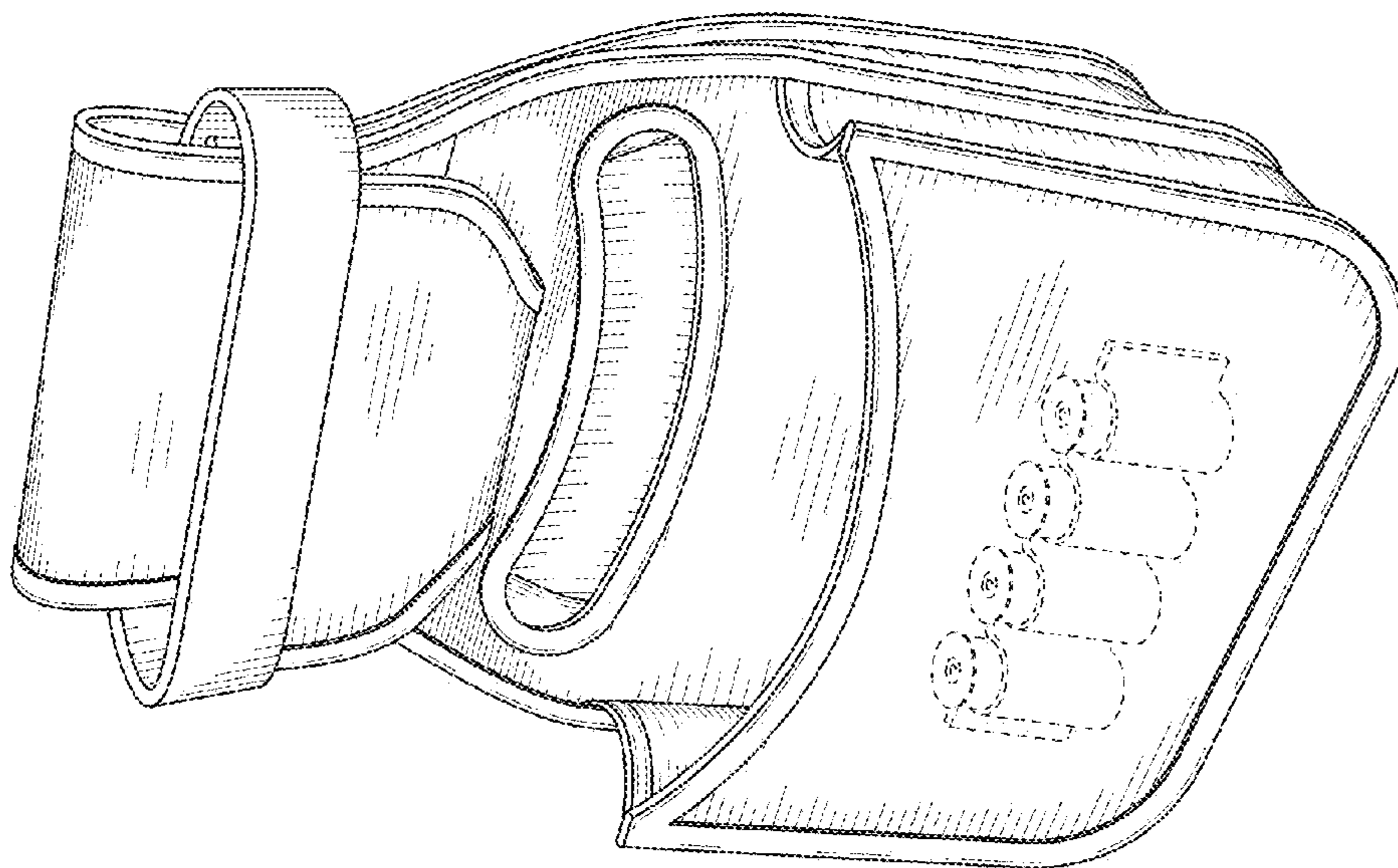

FIG. 8