



US0D1045392S

(12) **United States Design Patent**
Tidwell et al.

(10) **Patent No.: US D1,045,392 S**

(45) **Date of Patent: ** Oct. 8, 2024**

(54) **CHILD-RESISTANT CASE**

cannasupplies.ca/product/cr-sliding-tins-with-buttons/ (3 pages) (Year: 2021).*

(71) Applicants: **Justin Tidwell**, Brea, CA (US);
William Tidwell, Brea, CA (US)

(Continued)

(72) Inventors: **Justin Tidwell**, Brea, CA (US);
William Tidwell, Brea, CA (US)

Primary Examiner — Justin M Jonaitis
Assistant Examiner — Alexandria Dubus

(**) Term: **15 Years**

(74) *Attorney, Agent, or Firm* — Buche & Associates,
P.C.; John K. Buche; Bryce A. Johnson

(21) Appl. No.: **29/733,443**

(22) Filed: **May 1, 2020**

(57) **CLAIM**

Related U.S. Application Data

We claim the ornamental design for a “child-resistant case,” as shown and described.

(63) Continuation-in-part of application No. 16/854,827,
filed on Apr. 21, 2020, now Pat. No. 11,425,933,
(Continued)

DESCRIPTION

(51) **LOC (14) Cl.** **03-01**
(52) **U.S. Cl.**
USPC **D27/189**; D3/294

FIG. 1 is a front view of a child-resistant case in a closed configuration;

(58) **Field of Classification Search**
USPC D3/201, 203.1, 212, 263, 265, 266, 273,
D3/294; D9/420, 426, 430, 432;
D27/172, 186, 189–191; D19/102–106
(Continued)

FIG. 2 is a back view of the child-resistant case of FIG. 1;

FIG. 3 is a left side view of the child-resistant case of FIG. 1;

(56) **References Cited**

U.S. PATENT DOCUMENTS

1,926,839 A * 9/1933 Denels A24F 15/12
292/228
2,090,886 A * 8/1937 Dion A24F 15/12
292/87

FIG. 4 is a right side view of the child-resistant case of FIG. 1;

FIG. 5 is a top view of the child-resistant case of FIG. 1;

FIG. 6 is a bottom view of the child-resistant case of FIG. 1;

(Continued)

FOREIGN PATENT DOCUMENTS

CN 306849667 * 9/2021

FIG. 7 is a perspective view of the child-resistant case of FIG. 1;

FIG. 8 is a front view of the child-resistant case of FIG. 1 in an open configuration;

FIG. 9 is a perspective view of the child-resistant case of FIG. 1 in an open configuration;

FIG. 10 is an environmental view of the child-resistant case;

FIG. 11 is a perspective view of an alternative embodiment of a child-resistant case in an open configuration;

FIG. 12 is an environmental view of the child-resistant case;

FIG. 13 is a front view of an alternative embodiment of a child-resistant case in a closed configuration;

FIG. 14 is a back view of the child-resistant case of FIG. 13;

FIG. 15 is a left side view of the child-resistant case of FIG. 13;

OTHER PUBLICATIONS

CR Sliding Tins with Buttons-Cannasupplies, dated Dec. 2, 2021 [online], [retrieved Nov. 9, 2023]. Retrieved from internet, https://

(Continued)

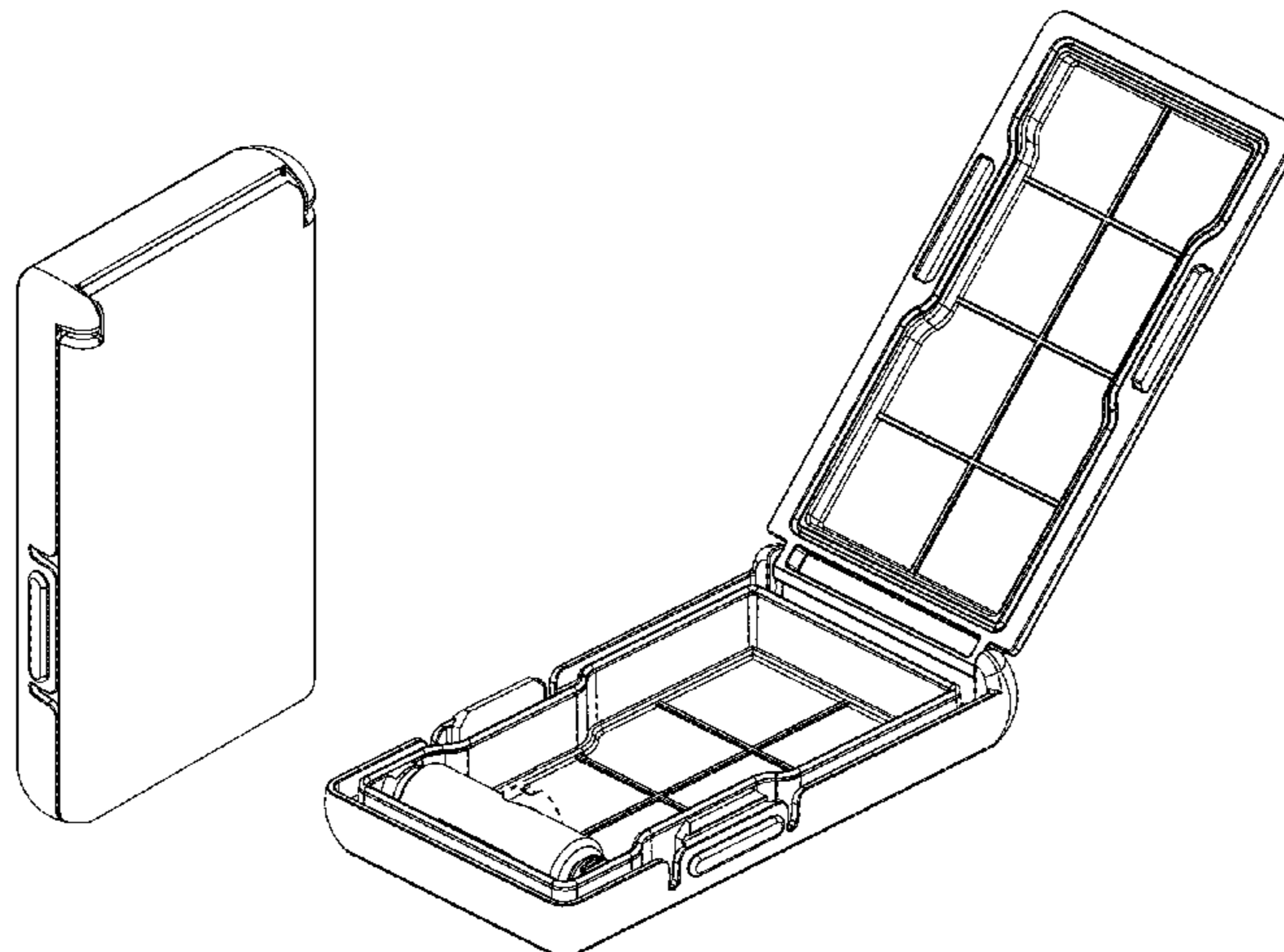

FIG. 16 is a right side view of the child-resistant case of FIG. 13;
 FIG. 17 is a top view of the child-resistant case of FIG. 13;
 FIG. 18 is a bottom view of the child-resistant case of FIG. 13;
 FIG. 19 is a perspective view of the child-resistant case of FIG. 13;
 FIG. 20 is a front view of the child-resistant case of FIG. 13 in an open configuration;
 FIG. 21 is a perspective view of the child-resistant case of FIG. 13 in an open configuration;
 FIG. 22 is an environmental view of the child-resistant case of FIG. 13;
 FIG. 23 is a front view of a child-resistant case;
 FIG. 24 is a back view of the child-resistant case of FIG. 23;
 FIG. 25 is a left side view of the child-resistant case of FIG. 23;
 FIG. 26 is a right side view of the child-resistant case of FIG. 23;
 FIG. 27 is a top view of the child-resistant case of FIG. 23;
 FIG. 28 is a bottom view of the child-resistant case of FIG. 23;
 FIG. 29 is a perspective view of the child-resistant case of FIG. 23;
 FIG. 30 is a front view of the child-resistant case of FIG. 23 in an open configuration;
 FIG. 31 is a perspective view of the child-resistant case of FIG. 23 in an open configuration; and,
 FIG. 32 is an environmental view of the child-resistant case of FIG. 23.
 Broken lines depict portions of the child-resistant case and form no part of the claimed design.

1 Claim, 21 Drawing Sheets

Related U.S. Application Data

which is a continuation-in-part of application No. 16/734,281, filed on Jan. 3, 2020, now Pat. No. 11,617,390, which is a continuation of application No. 29/717,611, filed on Dec. 18, 2019.

(58) **Field of Classification Search**

CPC B65D 85/10; B65D 43/16; B65D 43/22;

B65D 25/04; B65D 2215/02; A24F 15/12;
 A24F 15/00; A24F 15/01

See application file for complete search history.

(56)

References Cited

U.S. PATENT DOCUMENTS

D144,278	S	*	3/1946	Wohl	206/256
D255,038	S	*	5/1980	Itakura	D3/273
D379,552	S	*	5/1997	Vokebe	D27/189
D513,873	S	*	1/2006	Bochno	D3/294
D559,676	S	*	1/2008	Kutsch	D9/420
D564,348	S	*	3/2008	Kutsch	D9/420
D715,546	S	*	10/2014	Olsson	D3/266
D804,164	S	*	12/2017	Harper, IV	D3/203.1
D834,819	S	*	12/2018	Burek	D3/294
10,414,553	B2		9/2019	Ziering et al.		
10,624,430	B1	*	4/2020	Godwin, III	A24F 15/12
D890,421	S	*	7/2020	Godwin, III	D27/186
D891,693	S	*	7/2020	Godwin, III	D27/186
D893,095	S	*	8/2020	Ziering	D27/189
D935,765	S	*	11/2021	Toda	D3/206
2015/0259107	A1	*	9/2015	Hoagland	A45D 40/22 206/223
2017/0137167	A1	*	5/2017	Warner	B65D 43/22
2017/0137184	A1	*	5/2017	Burek	B65D 43/22
2017/0349338	A1	*	12/2017	Ziering	A24F 15/10
2021/0186094	A1	*	6/2021	Tidwell	B65D 85/109
2022/0363454	A1	*	11/2022	Hession	A24F 23/00
2023/0150753	A1	*	5/2023	Clayton	B65D 43/165 206/443

OTHER PUBLICATIONS

CR SnapTech Pre-Roll Joint Case-Medium, dated Oct. 25, 2021 [online], [retrieved Nov. 9, 2023]. Retrieved from internet, <https://marijuanapackaging.com/products/child-resistant-snaptech-pre-roll-joint-case-medium-black-plastic-240-count> (4 pages) (Year: 2021).*

Hinged Tin-Cannasupplies, dated Feb. 6, 2021 [online], [retrieved Nov. 9, 2023], Retrieved from internet, <https://cannasupplies.ca/product/hinged-tin/> (3 pages) (Year: 2023).*

CR SnapTech Pre-Roll Joint Case-Small, Posting date unavailable, [online], [retrieved Nov. 9, 2023], Retrieved from internet, <https://marijuanapackaging.com/products/child-resistant-snap-box-edible-pre-roll-joint-case-small-black-plastic-450-count> (4 pages) (Year: 2023).*

Pre-Roll Packaging Tin-Child Resistant, Posting date unavailable, [online], [retrieved Nov. 9, 2023]. Retrieved from internet, <https://creativelabz843.com/collections/white-label-cannabis-packaging/products/white-pre-roll-packaging-tin-6x-109mm-cones-child-resistant> (4 pages) (Year: 2023).*

* cited by examiner

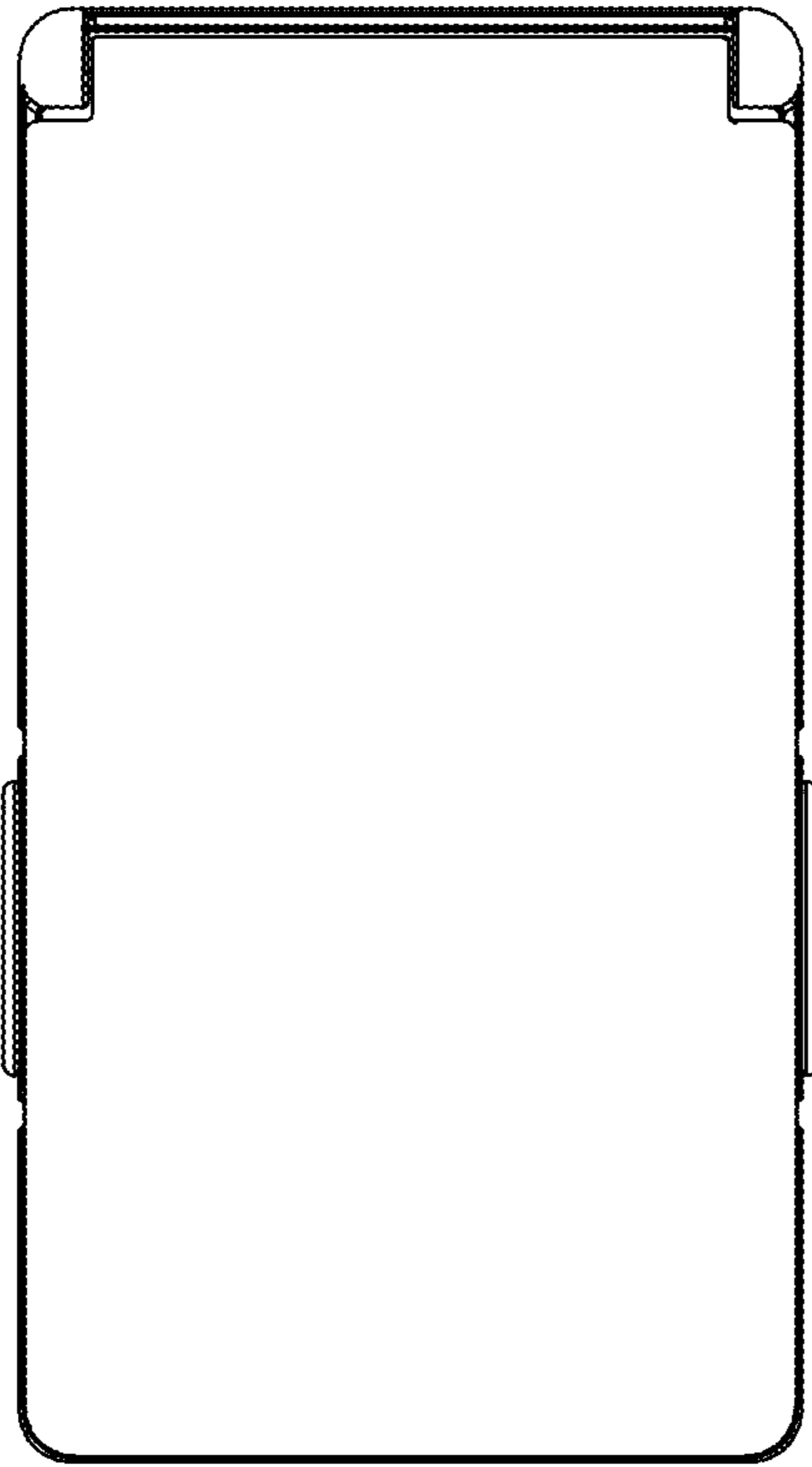

FIG. 1

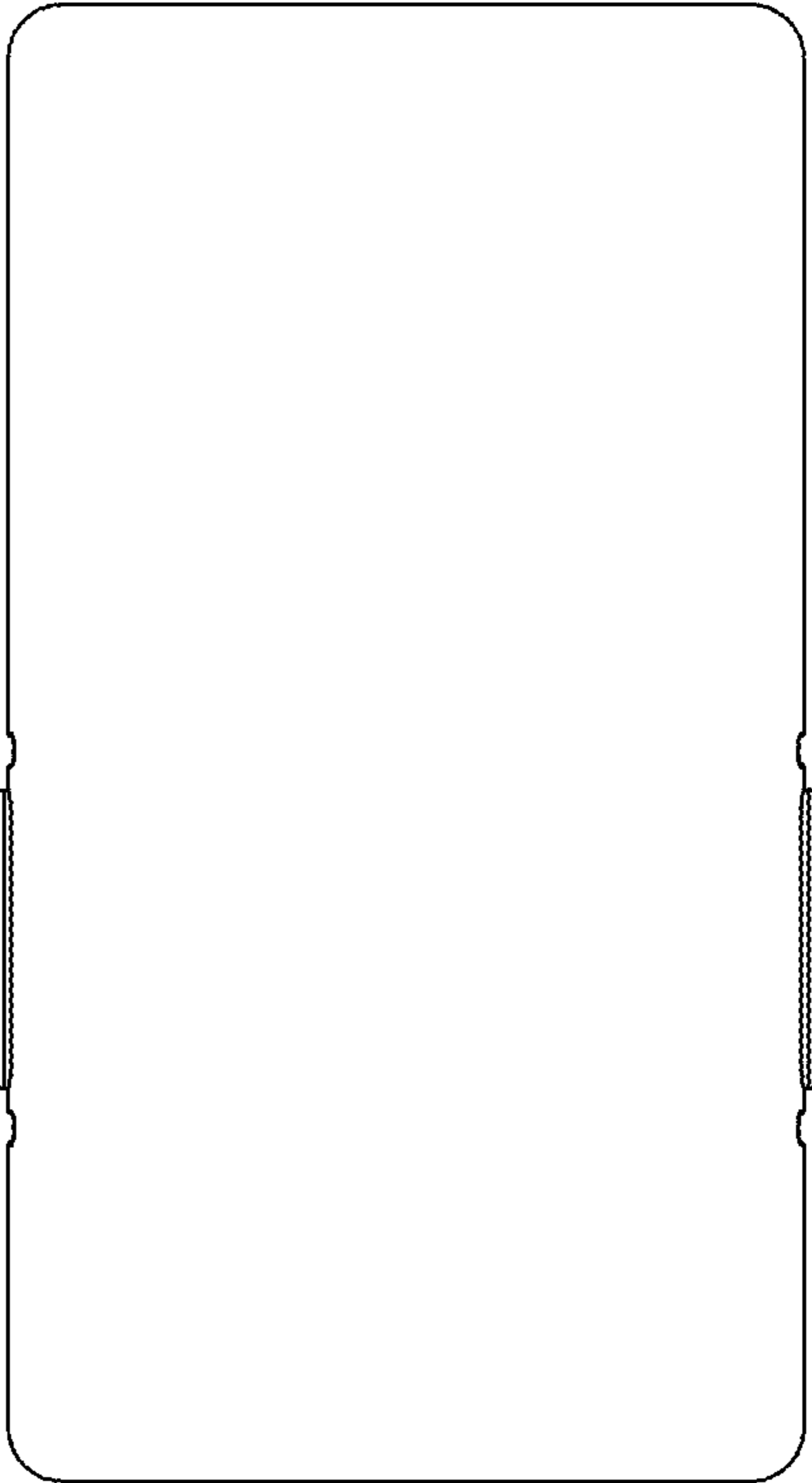

FIG. 2

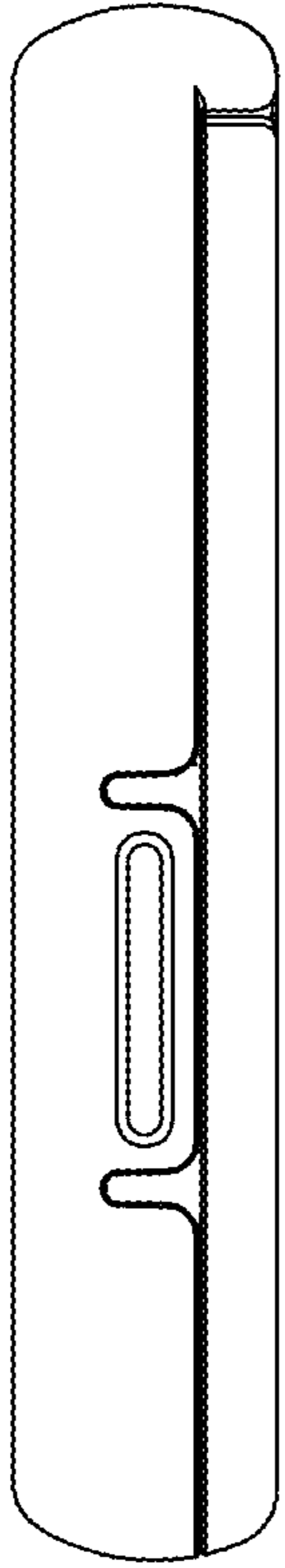

FIG. 3

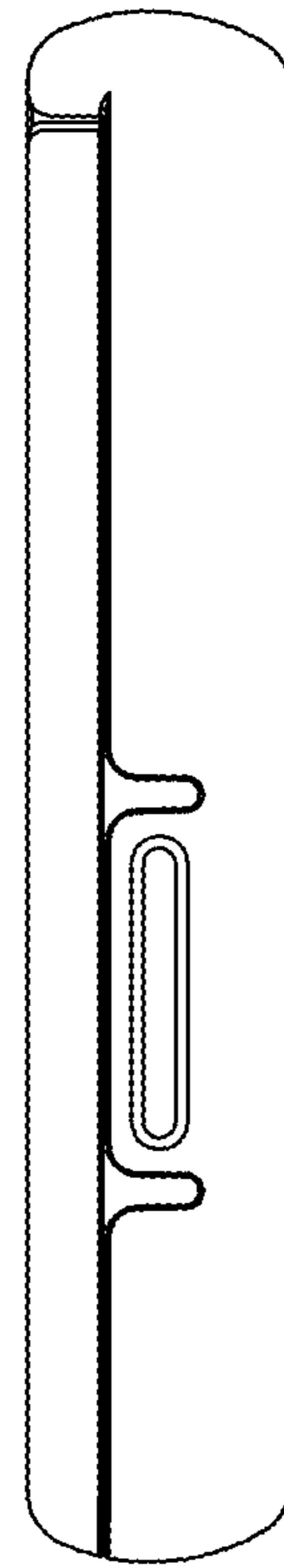

FIG. 4

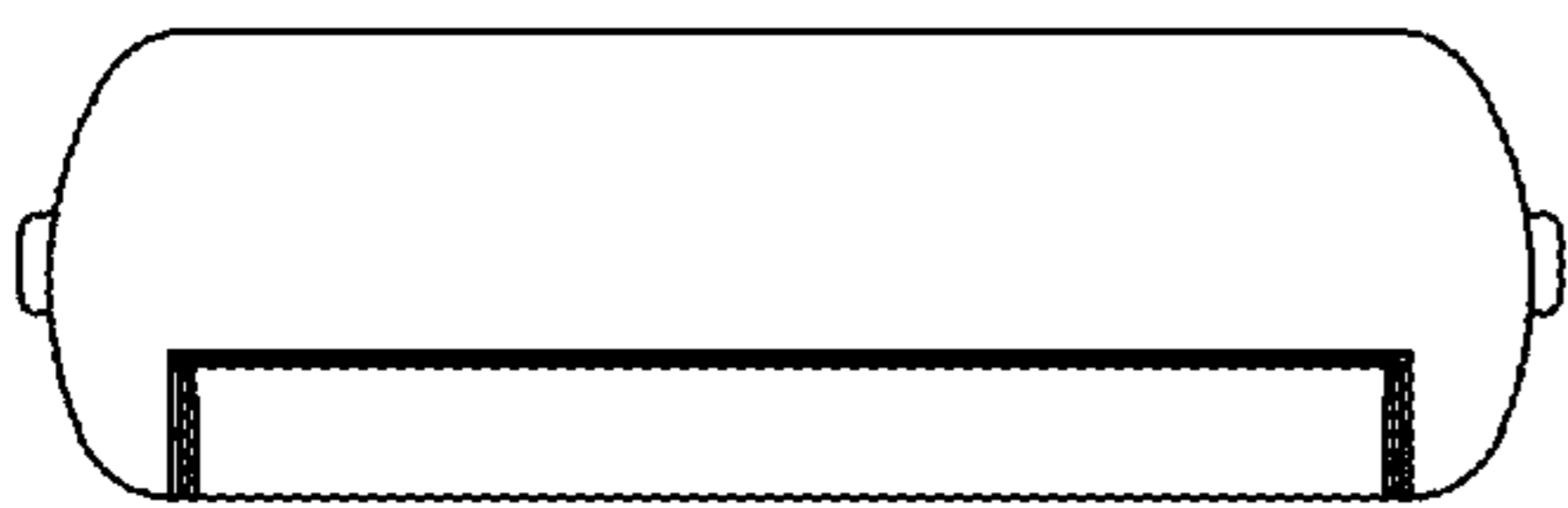

FIG. 5

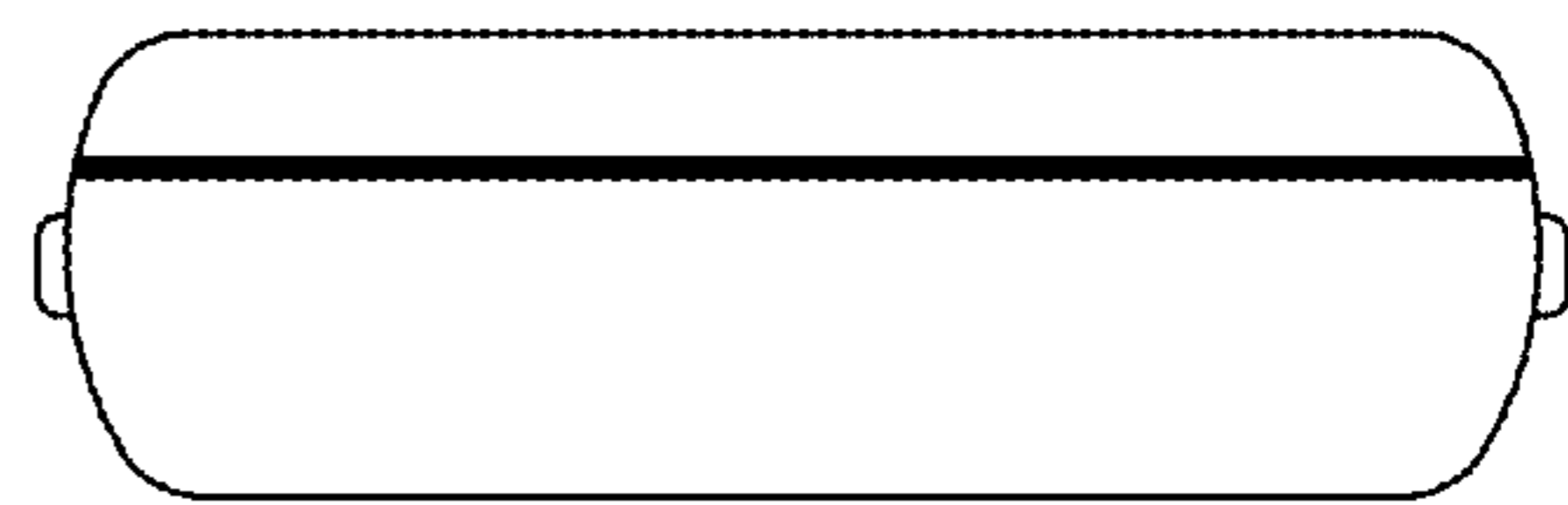

FIG. 6

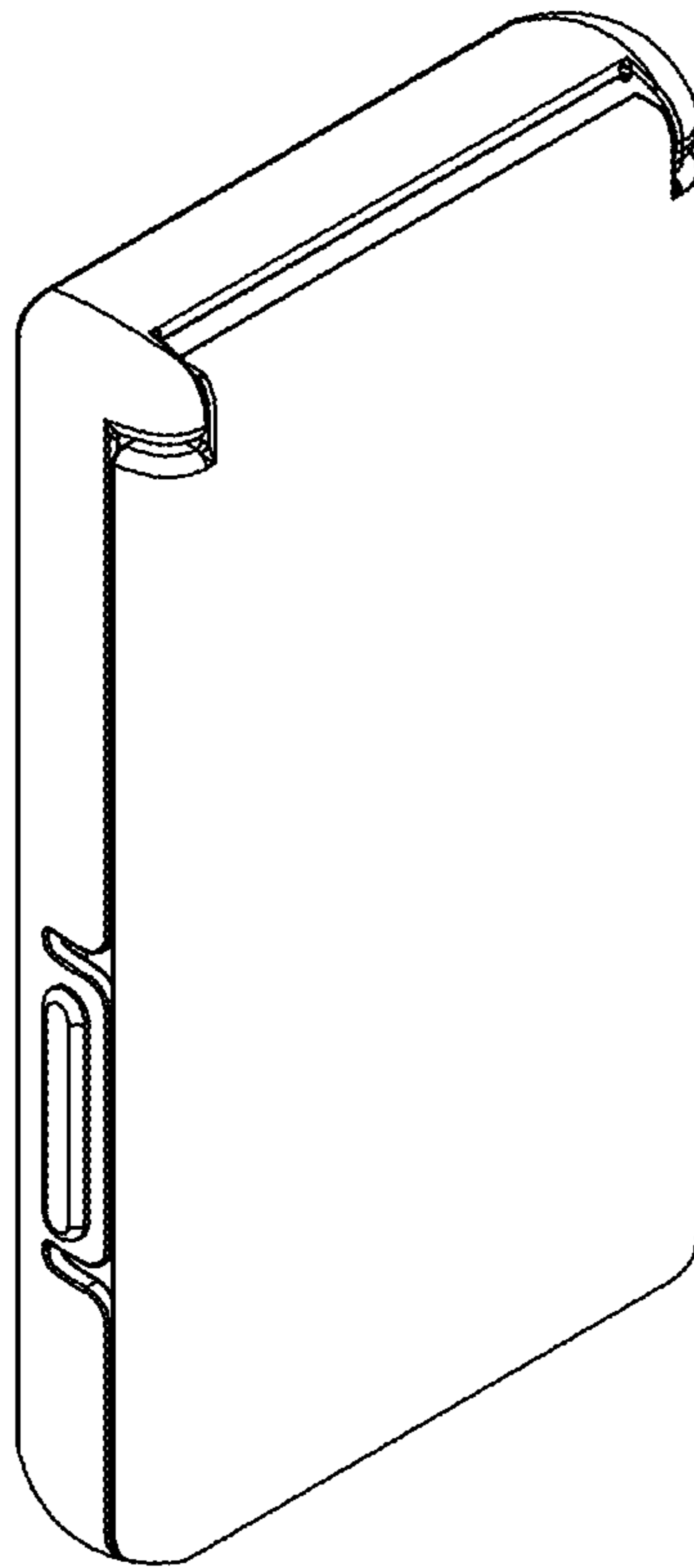

FIG. 7

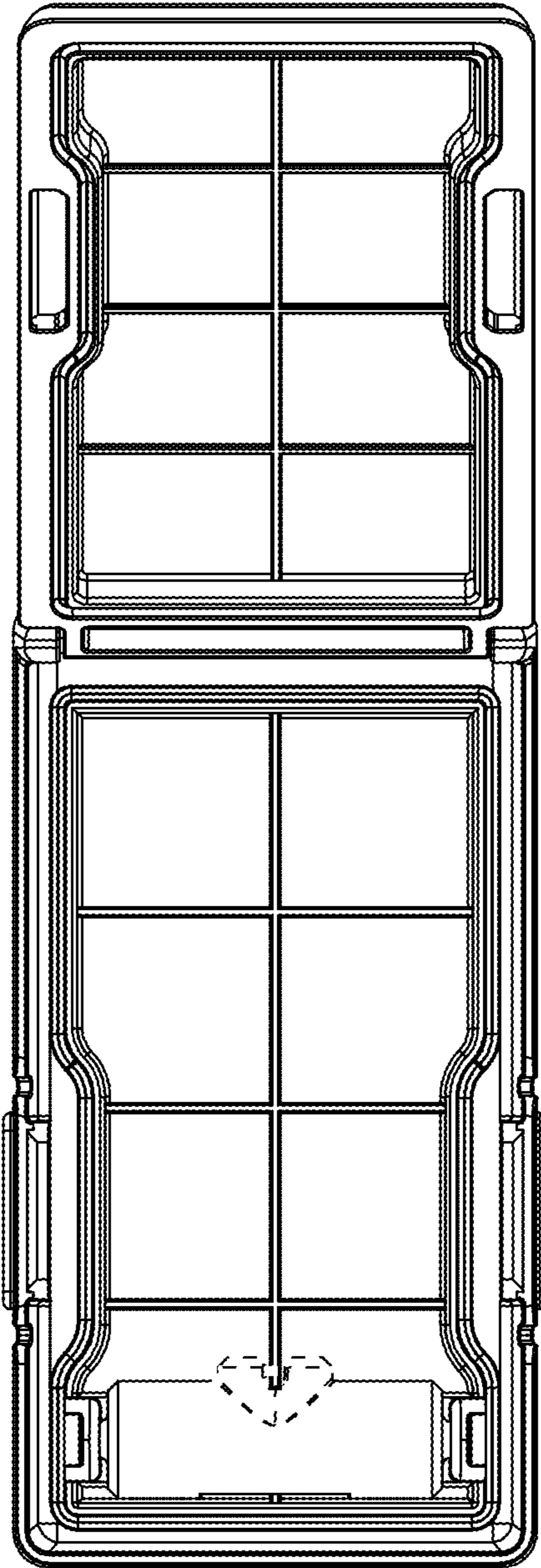

FIG. 8

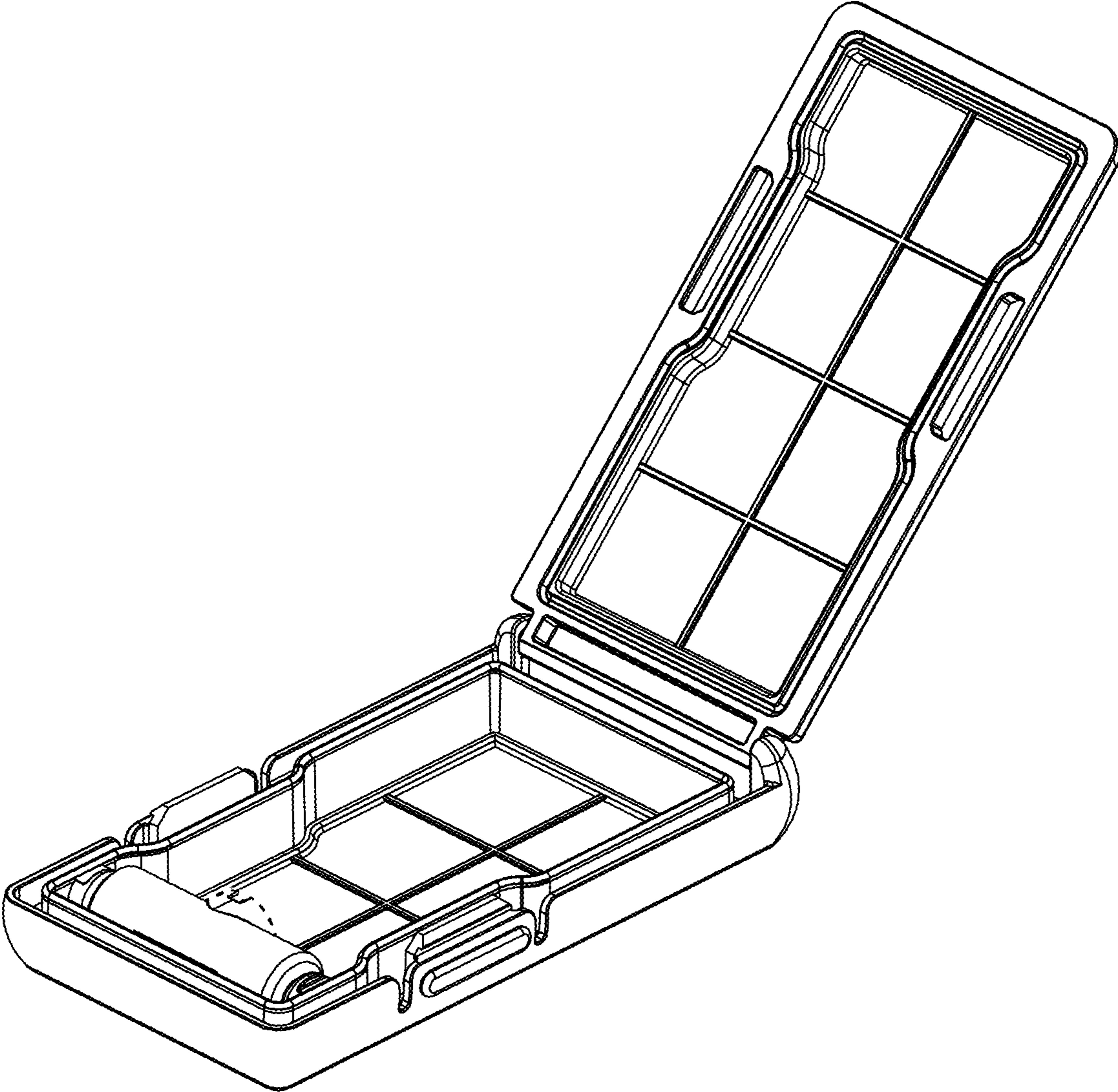

FIG. 9

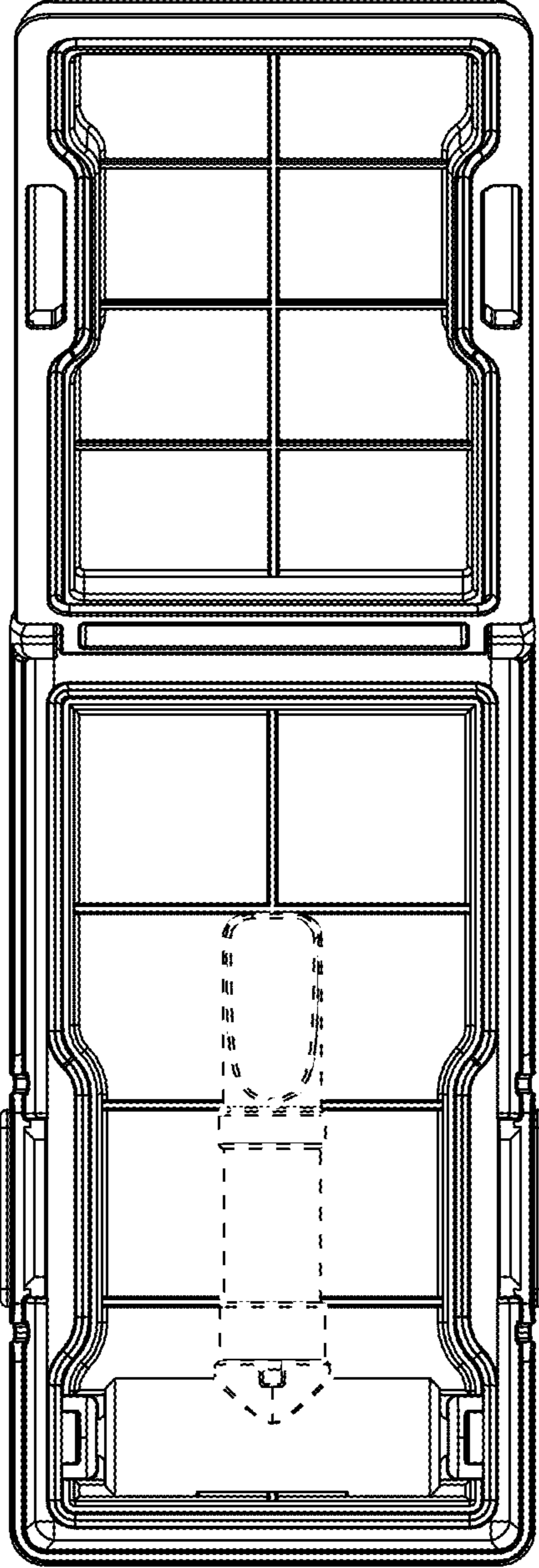

FIG. 10

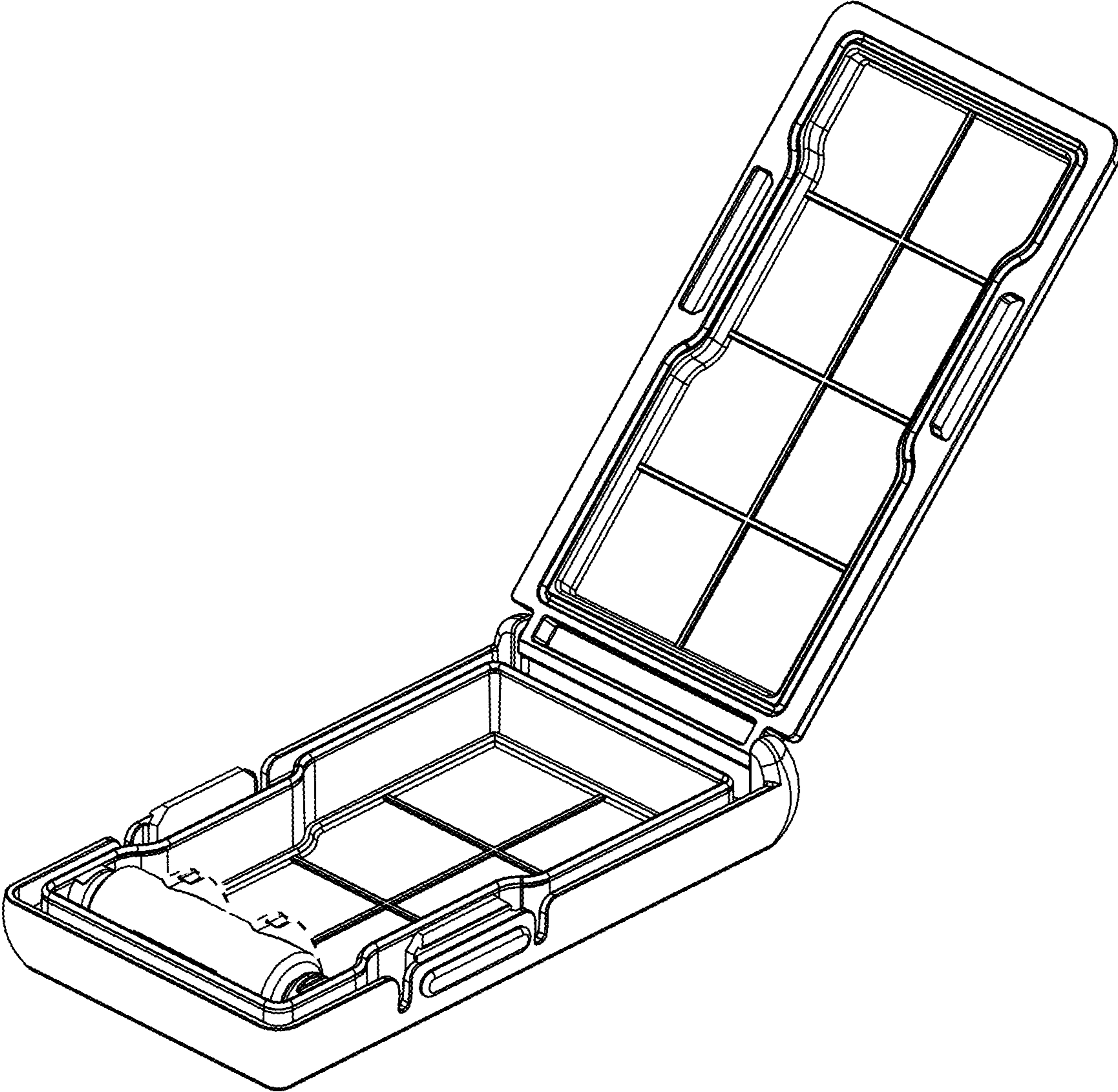

FIG. 11

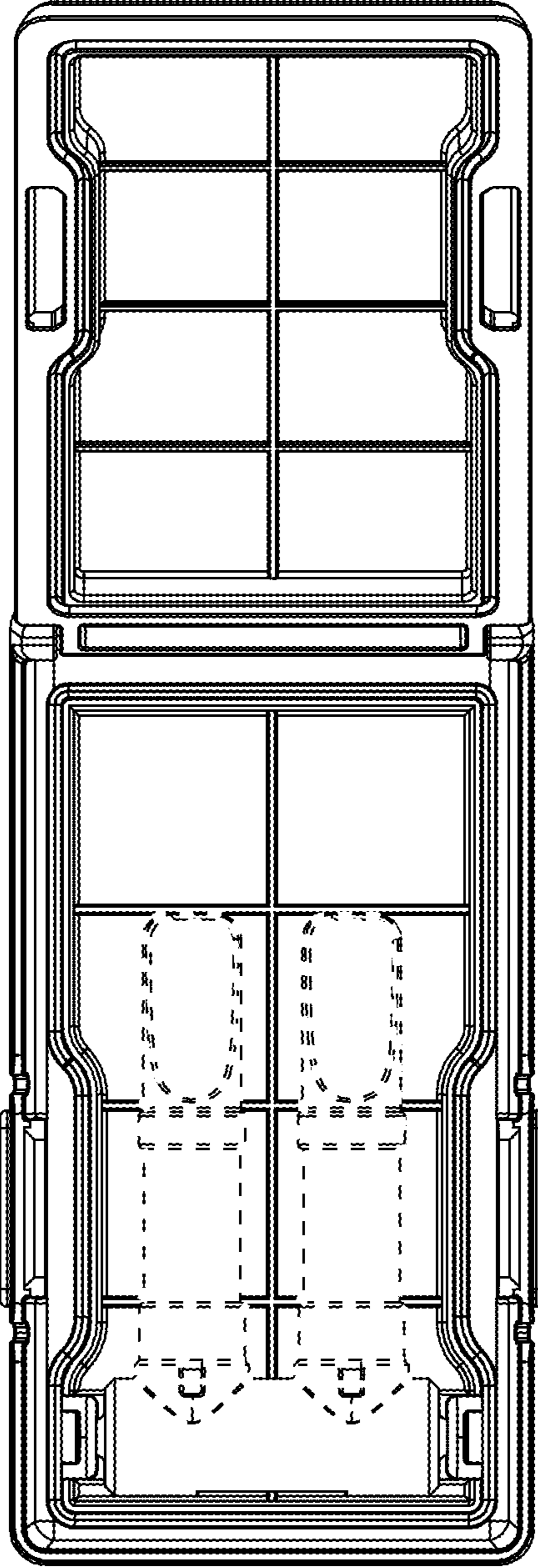

FIG. 12

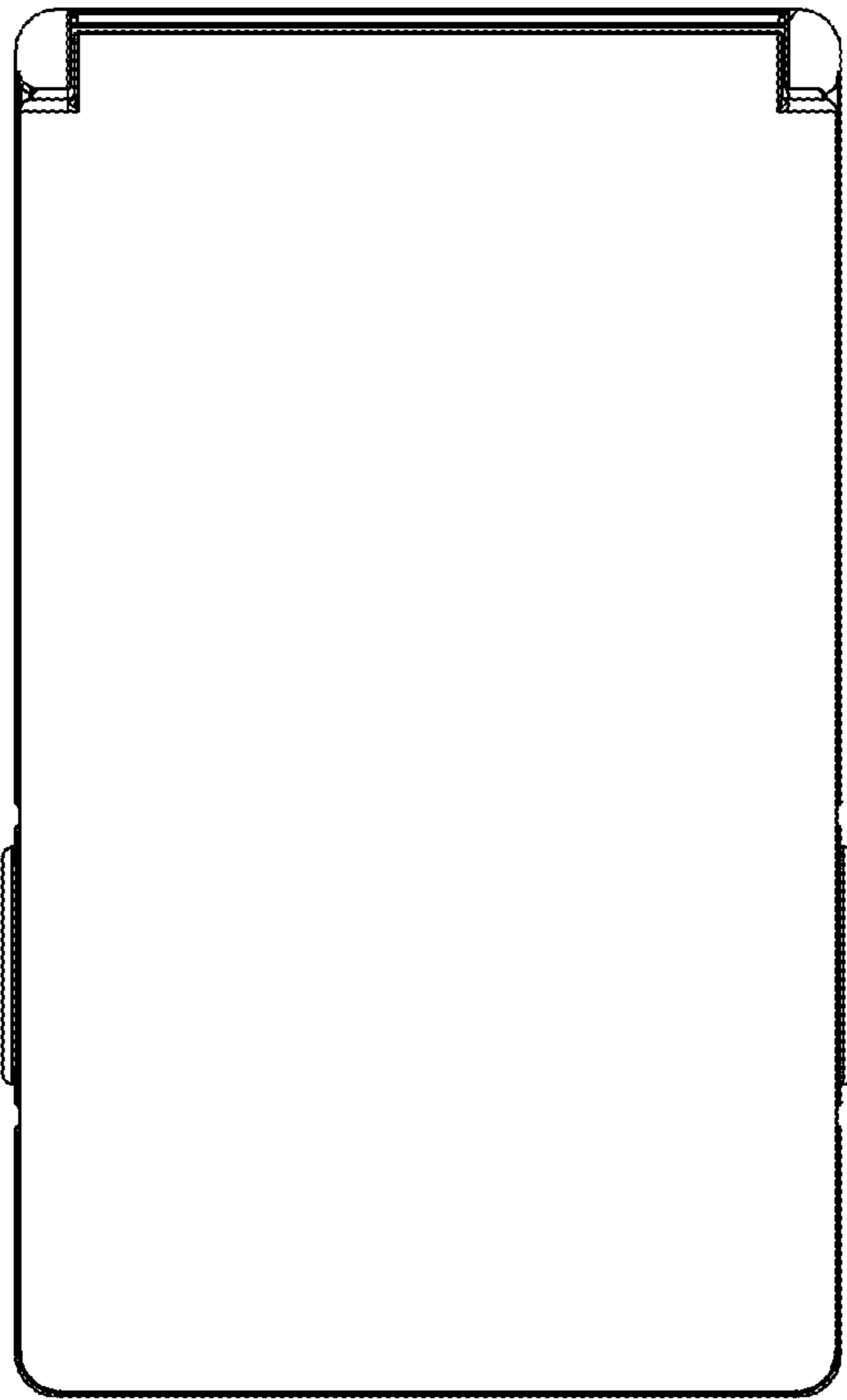

FIG. 13

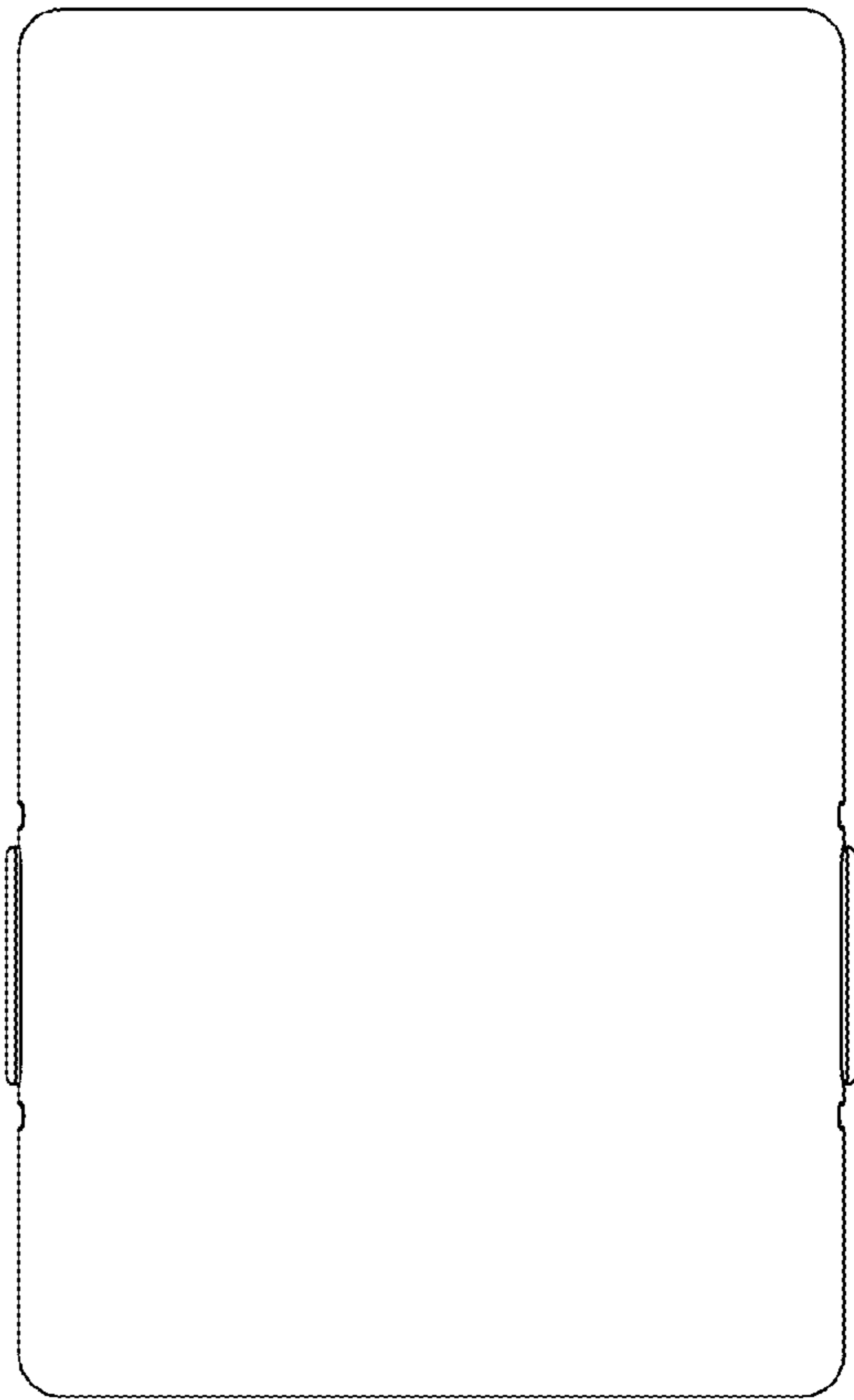

FIG. 14

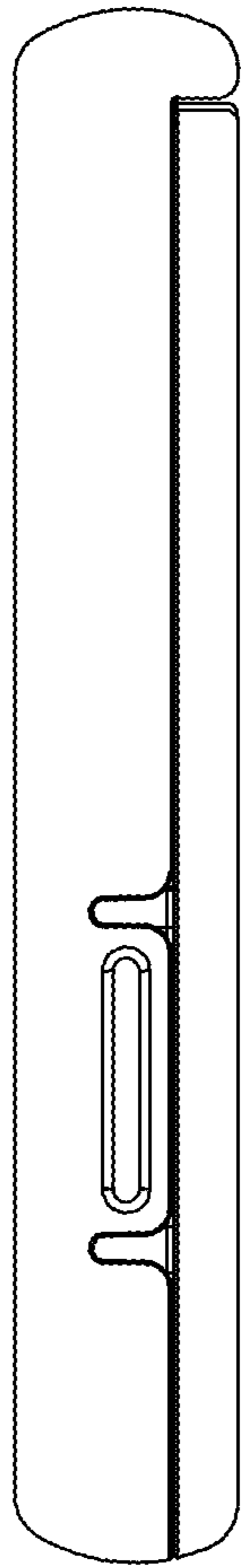

FIG. 15

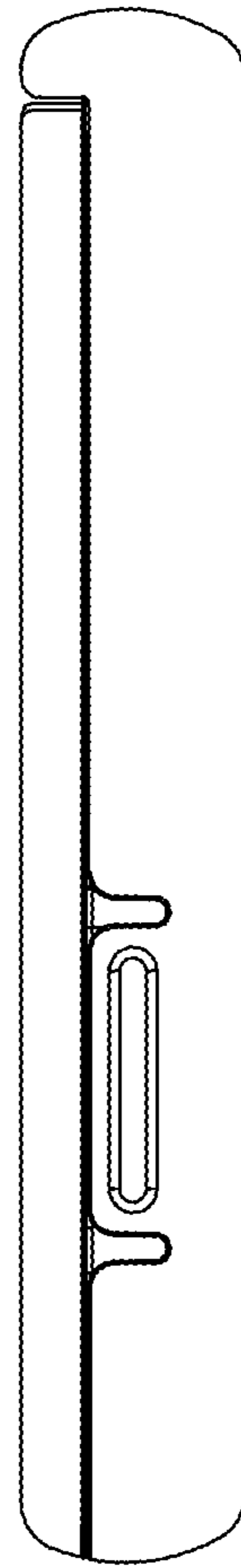

FIG. 16

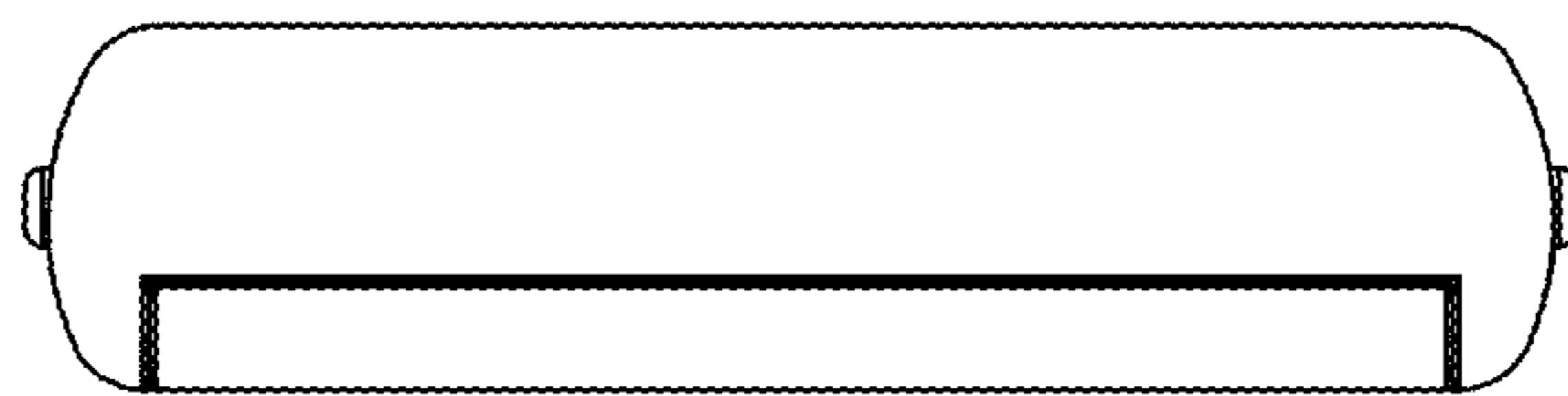

FIG. 17

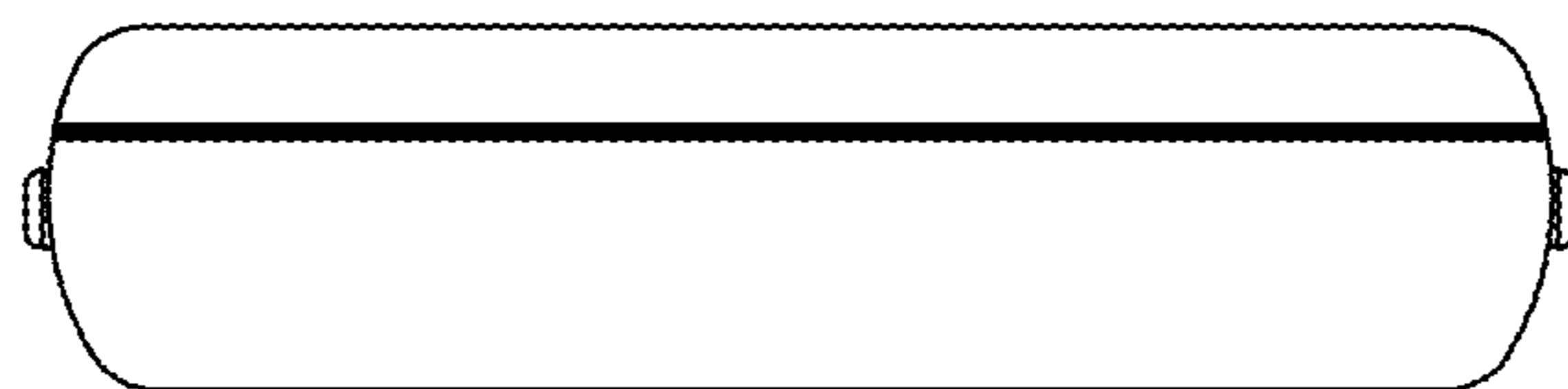

FIG. 18

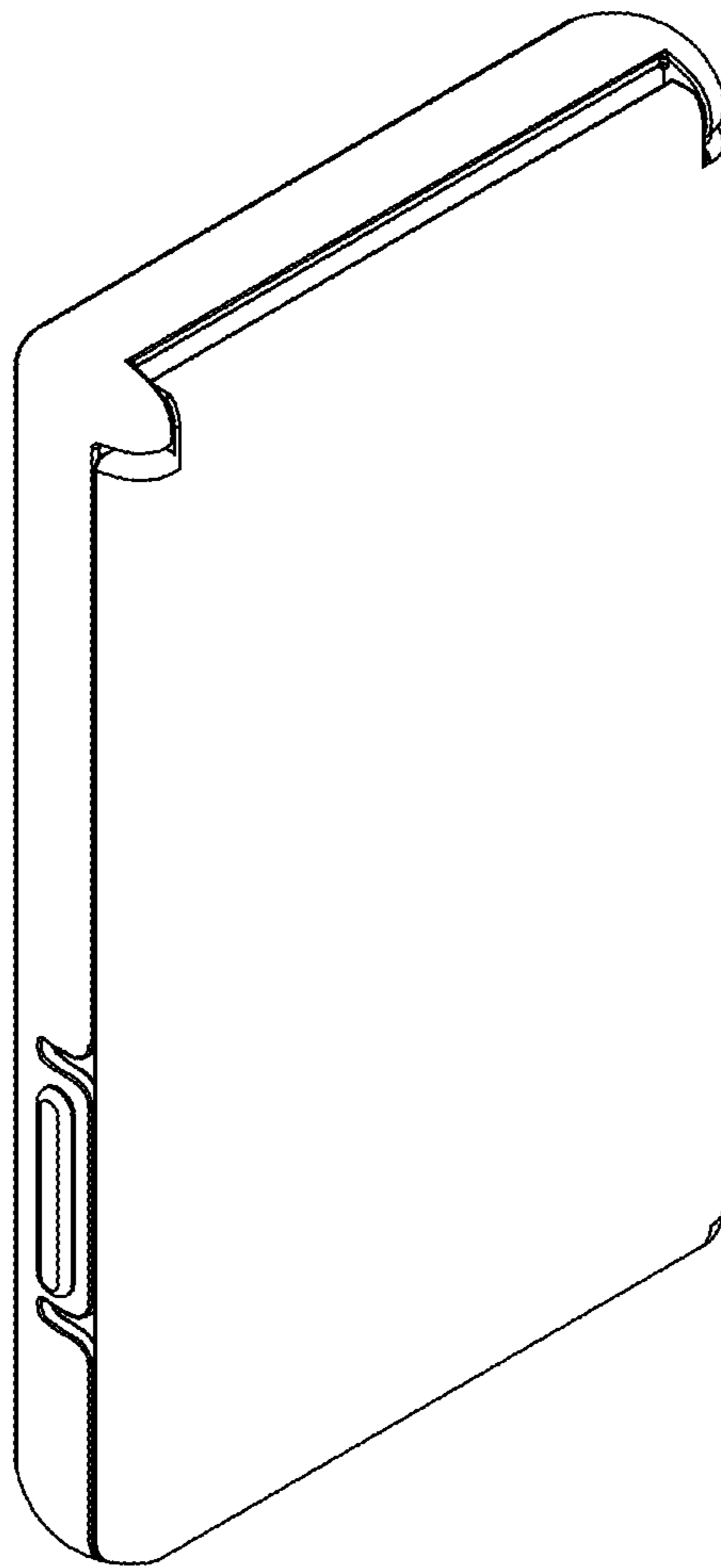

FIG. 19

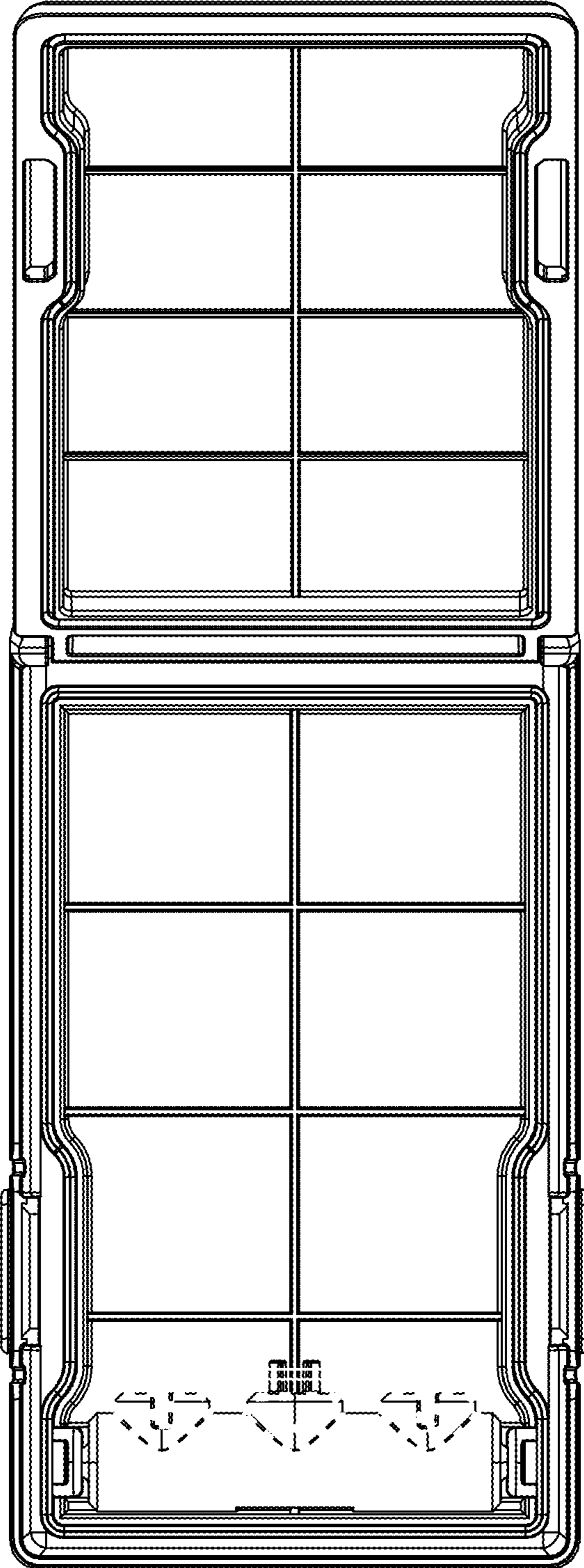

FIG. 20

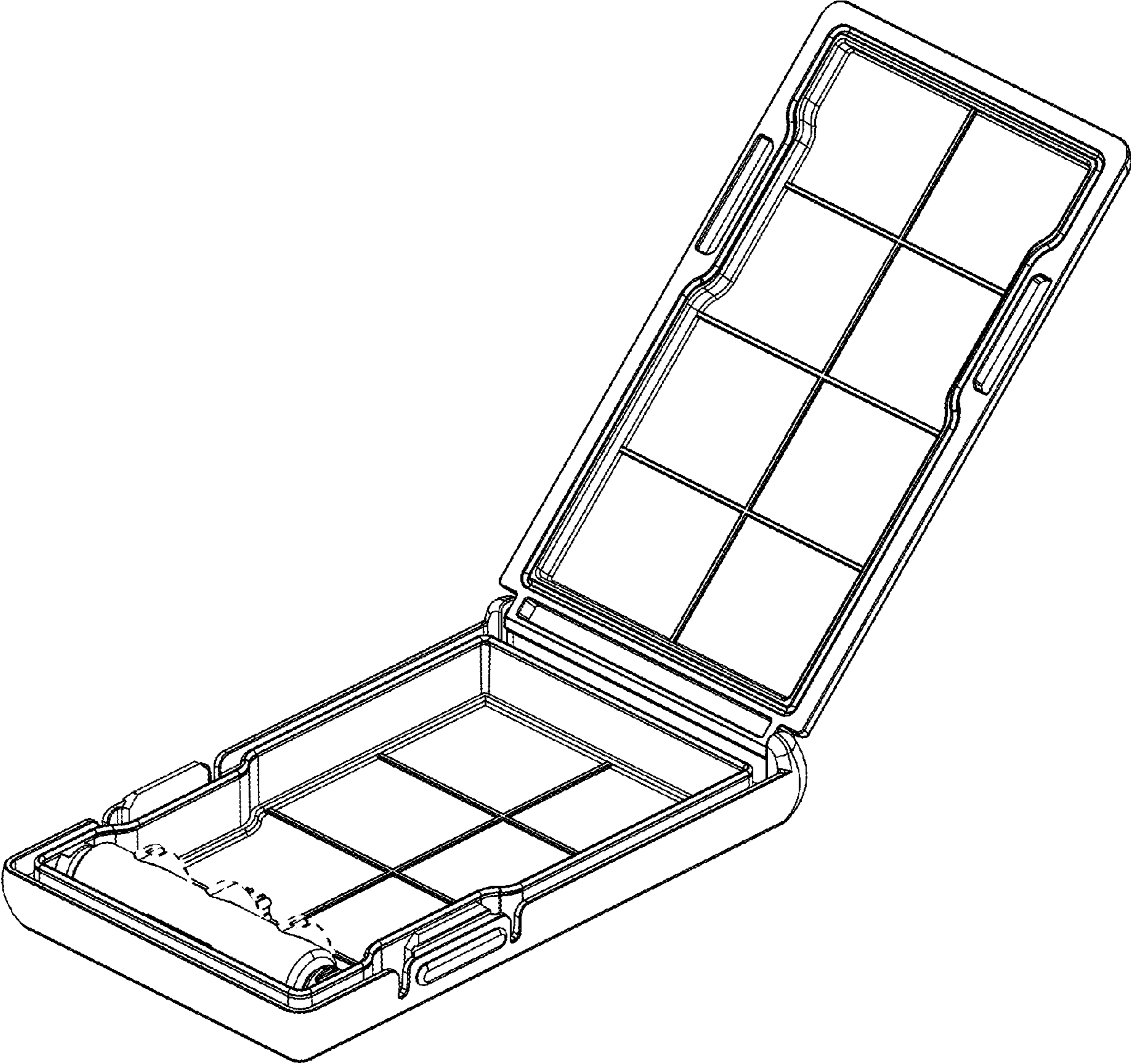

FIG. 21

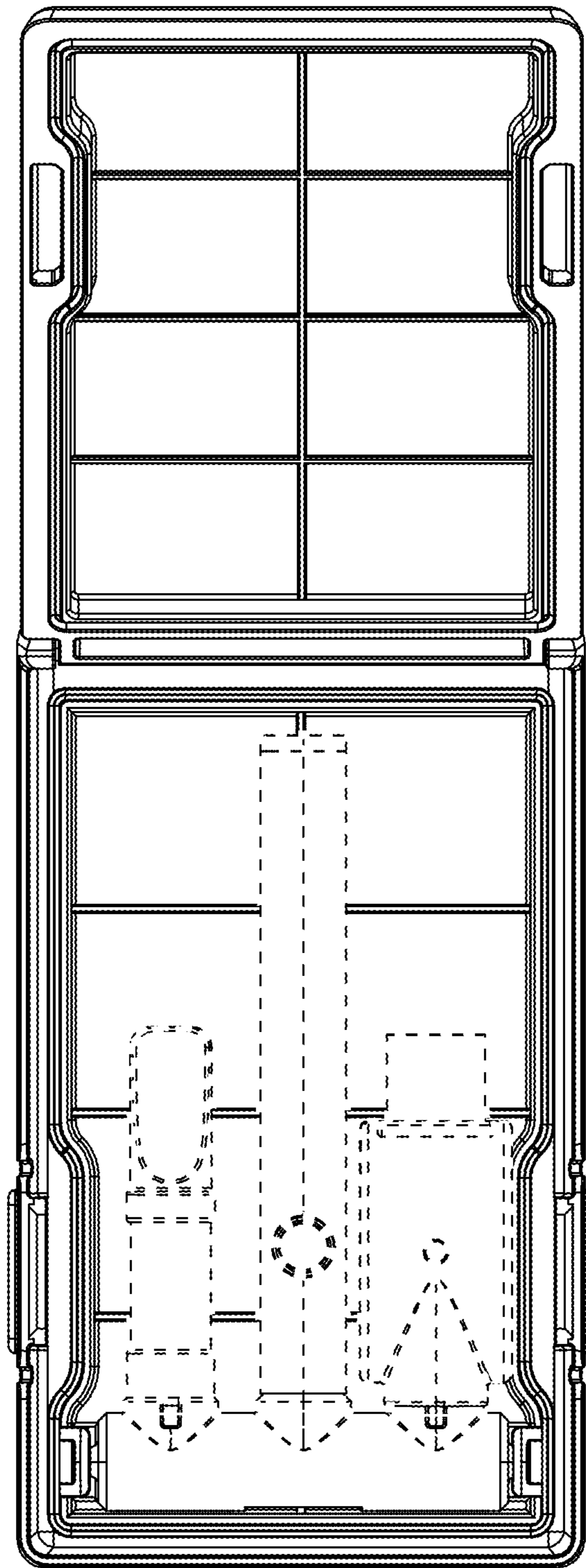

FIG. 22

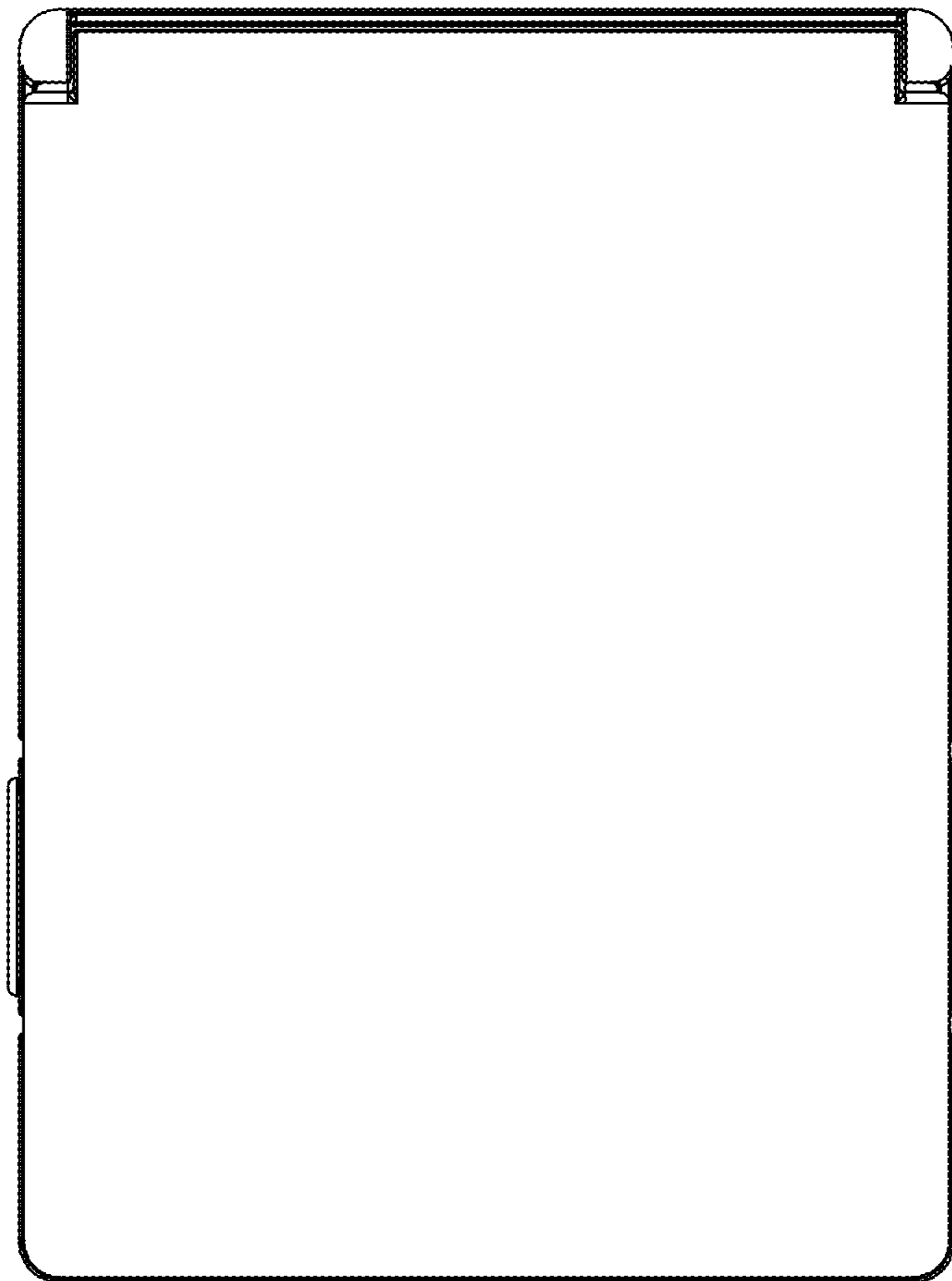

FIG. 23

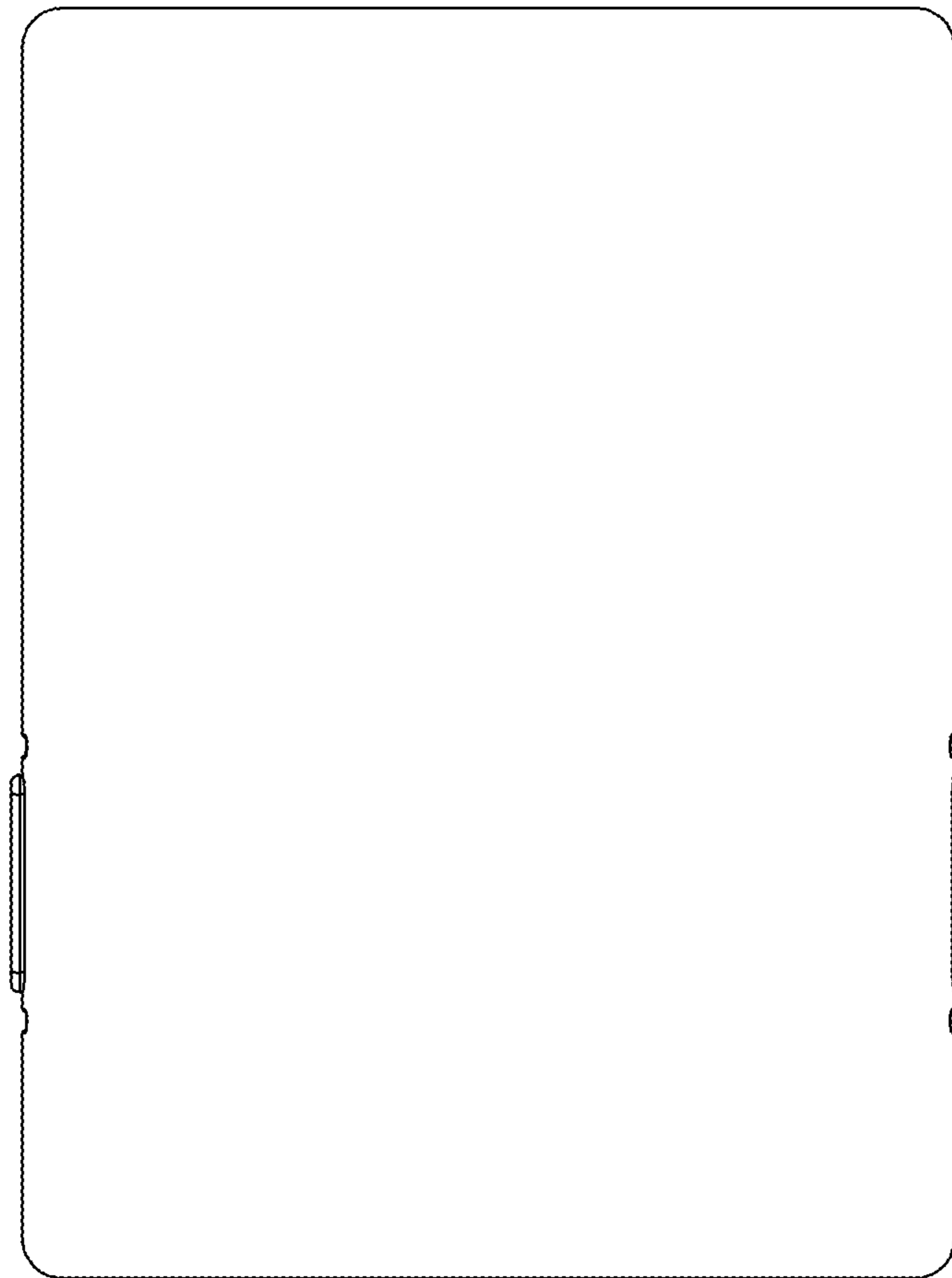

FIG. 24

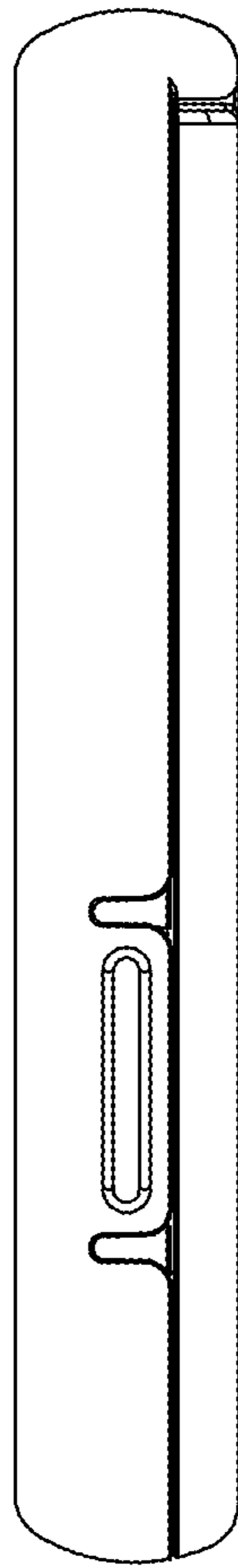

FIG. 25

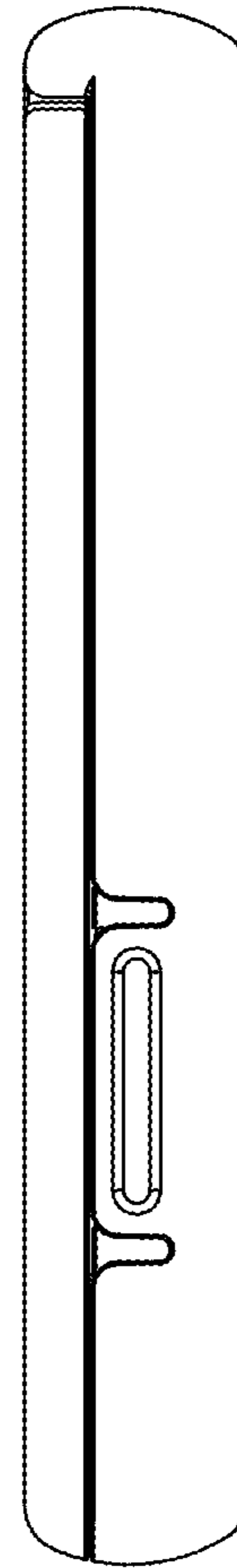

FIG. 26

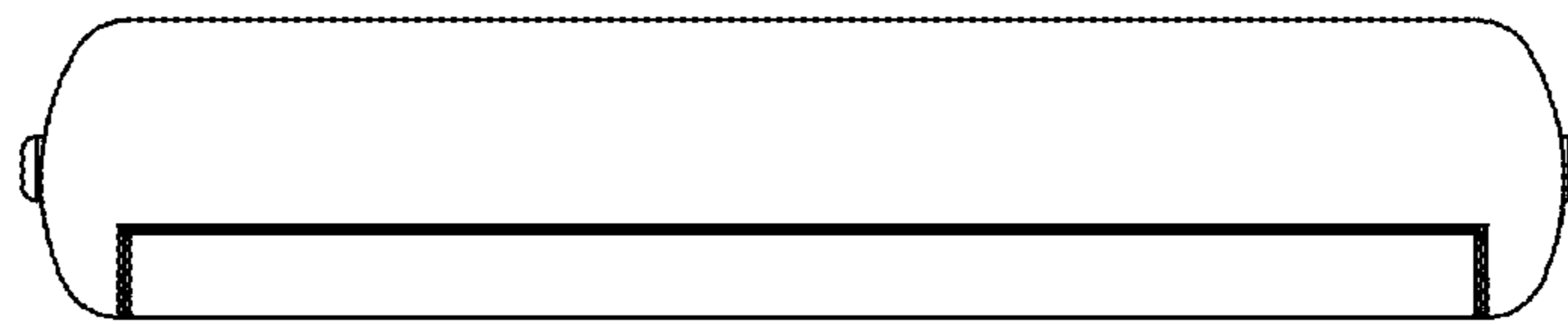

FIG. 27

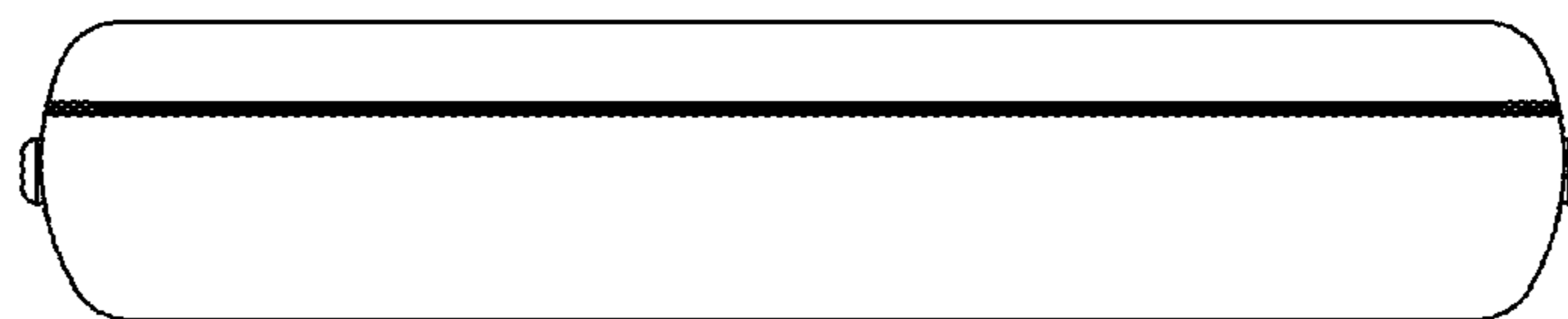

FIG. 28

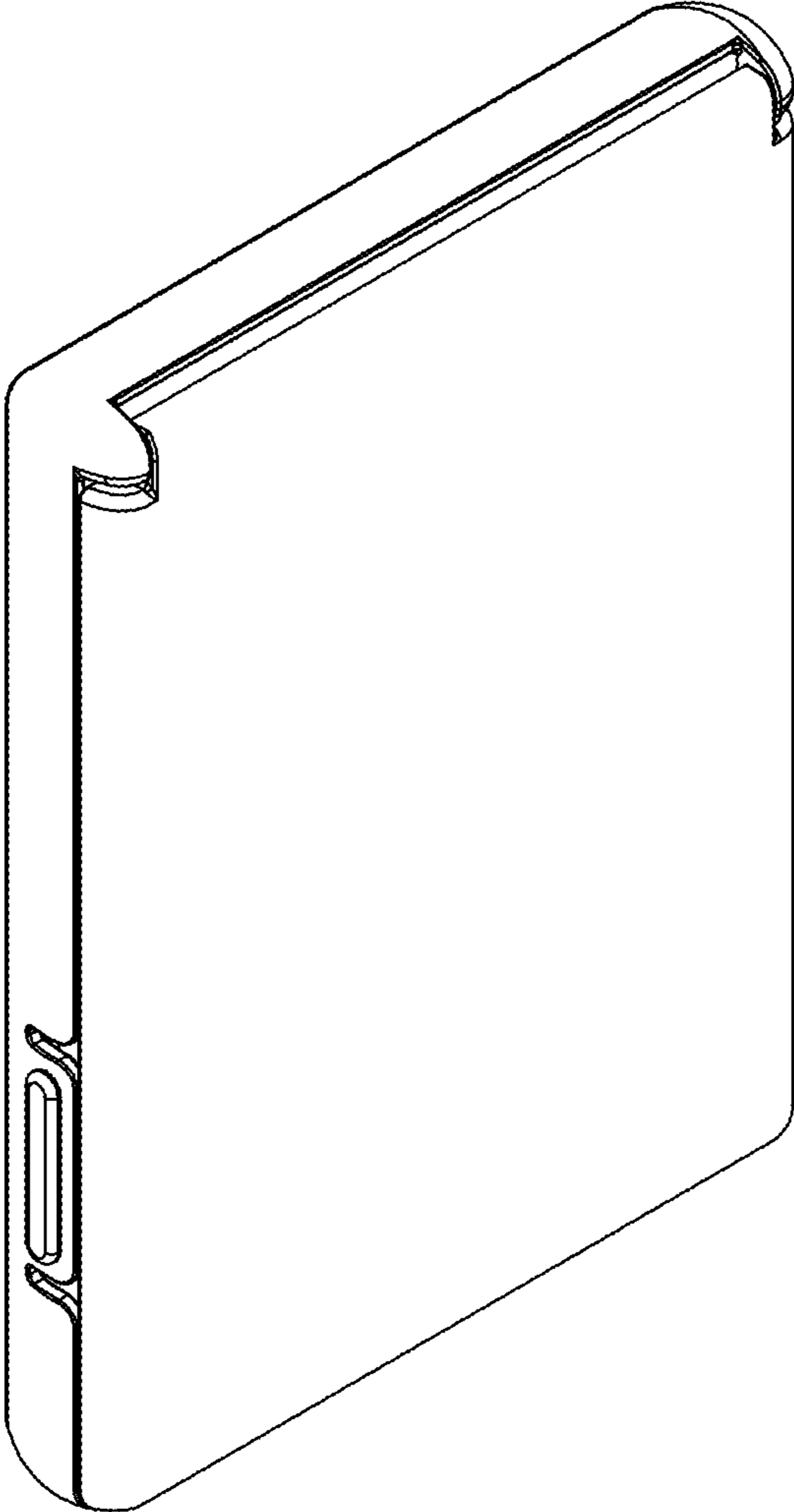

FIG. 29

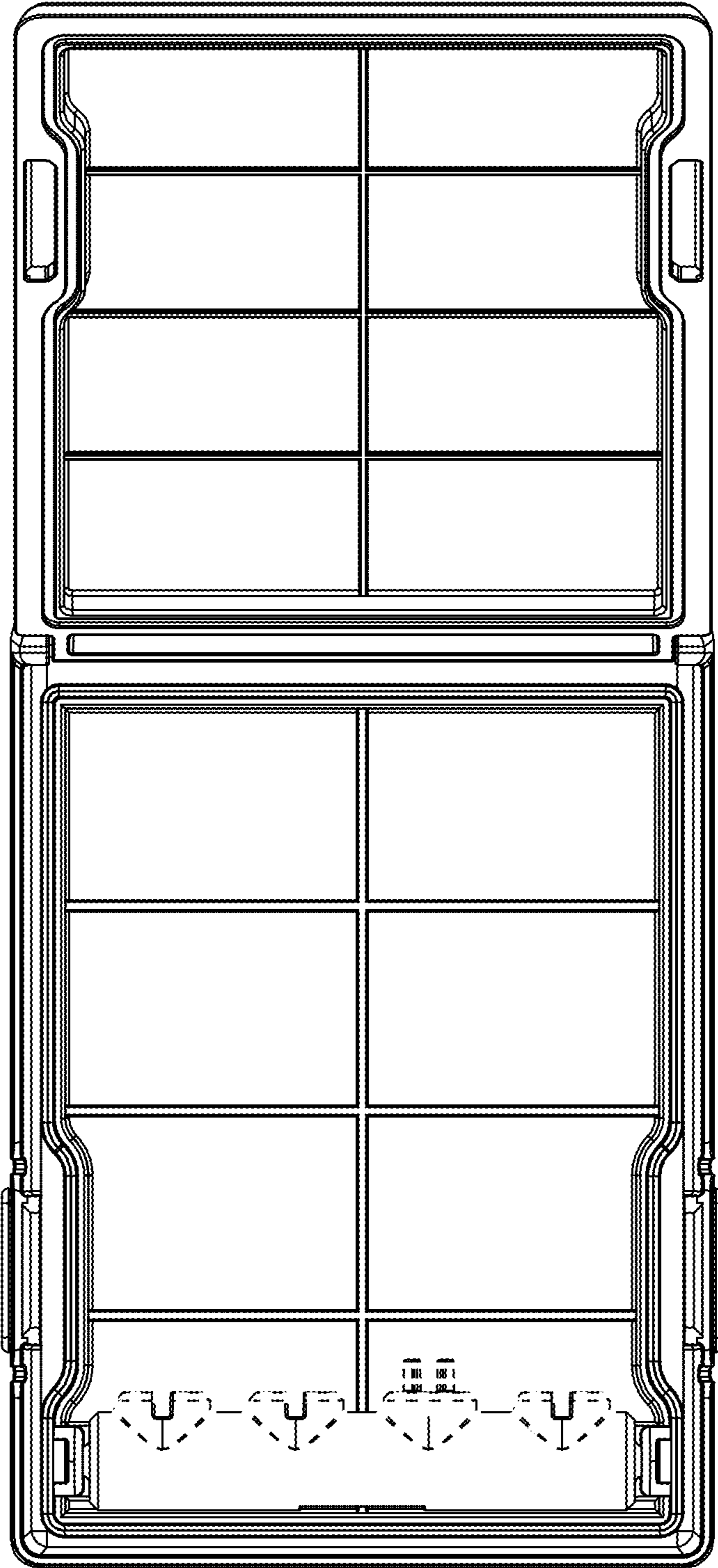

FIG. 30

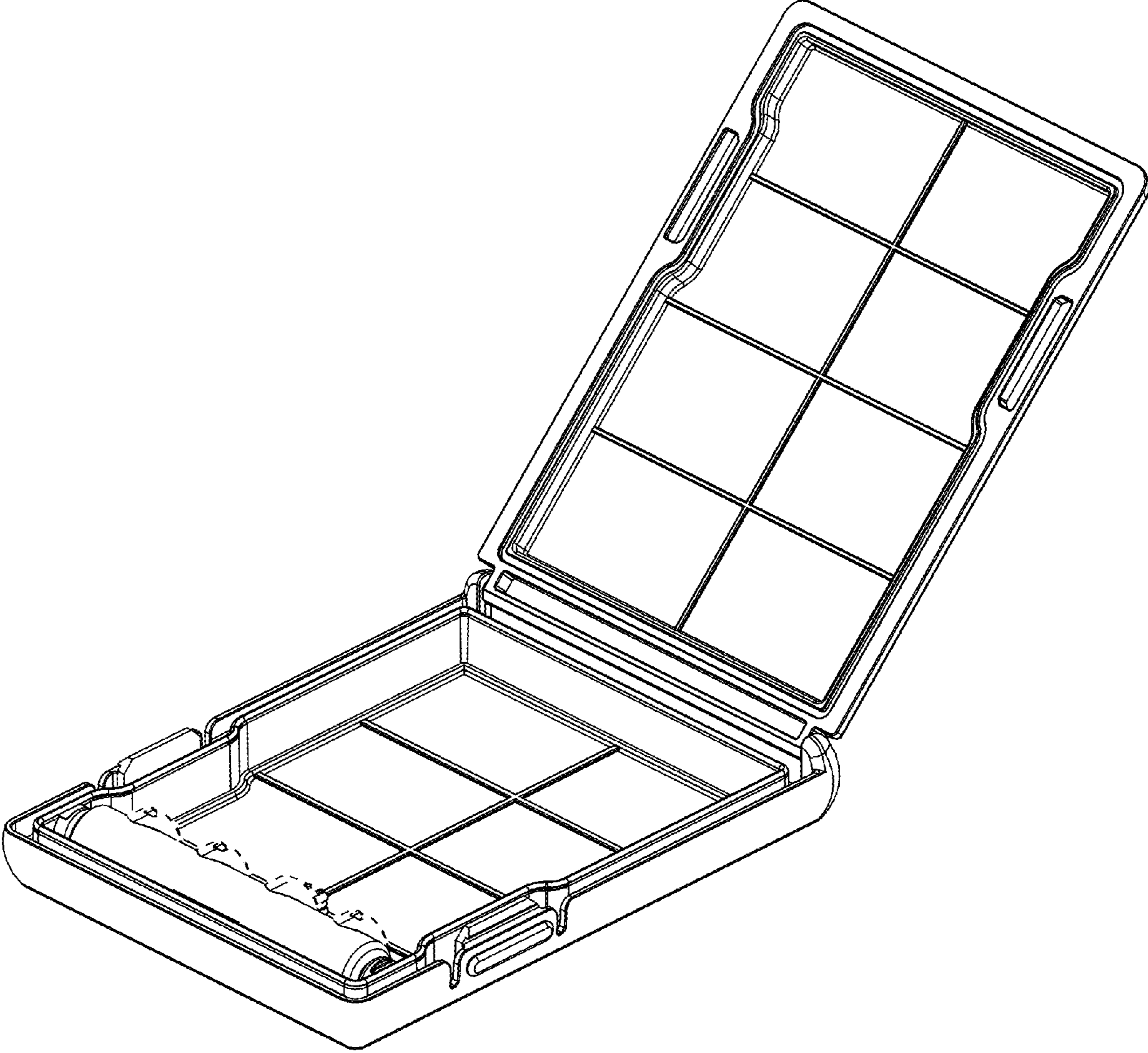

FIG. 31

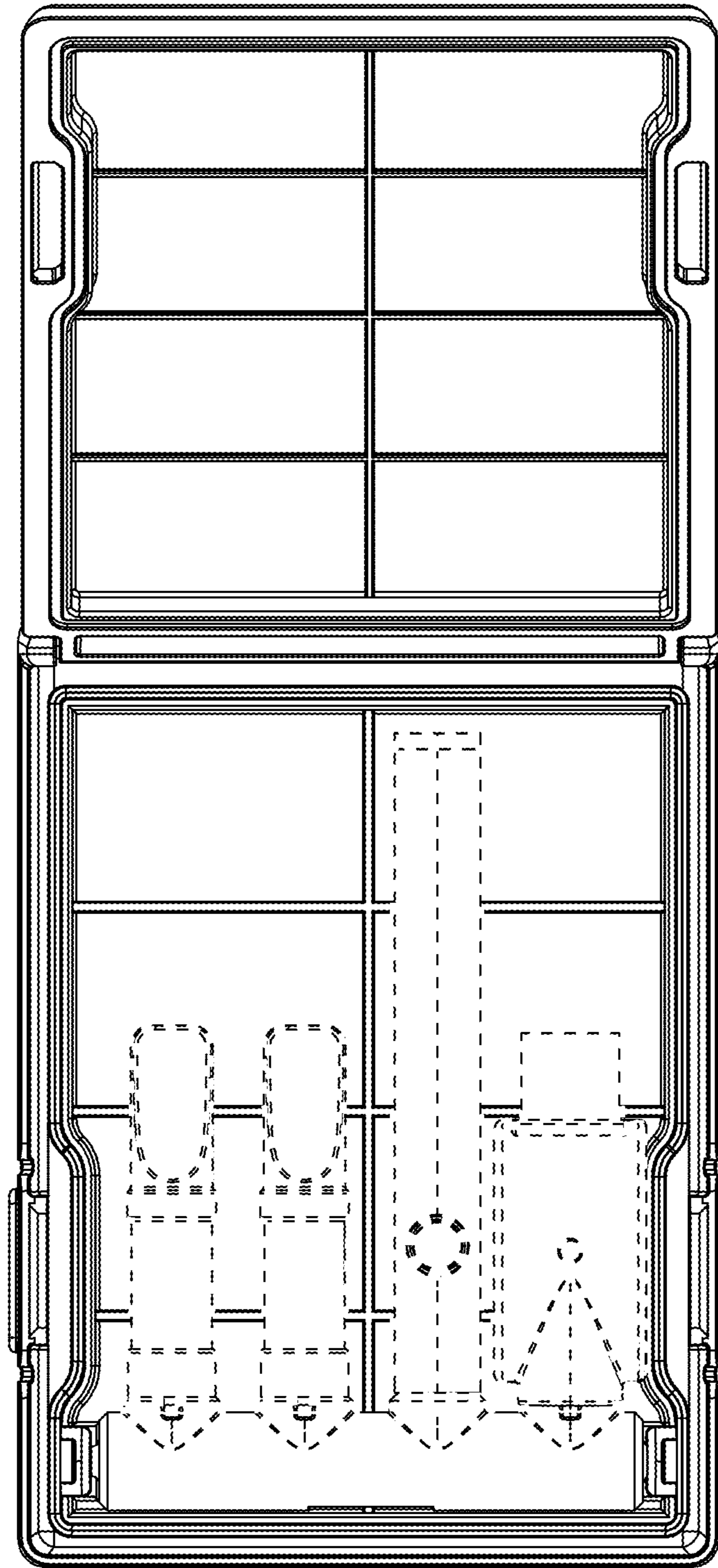

FIG. 32